

# SCIENTIFIC AMERICAN

[Entered at the Post Office of New York, N. Y., as Second Class Matter. Copyright, 1909, by Munn & Co.]

Vol. C.—No. 4.  
ESTABLISHED 1845.]

NEW YORK, JANUARY 23, 1909.

[ 10 CENTS A COPY  
\$3.00 A YEAR.]

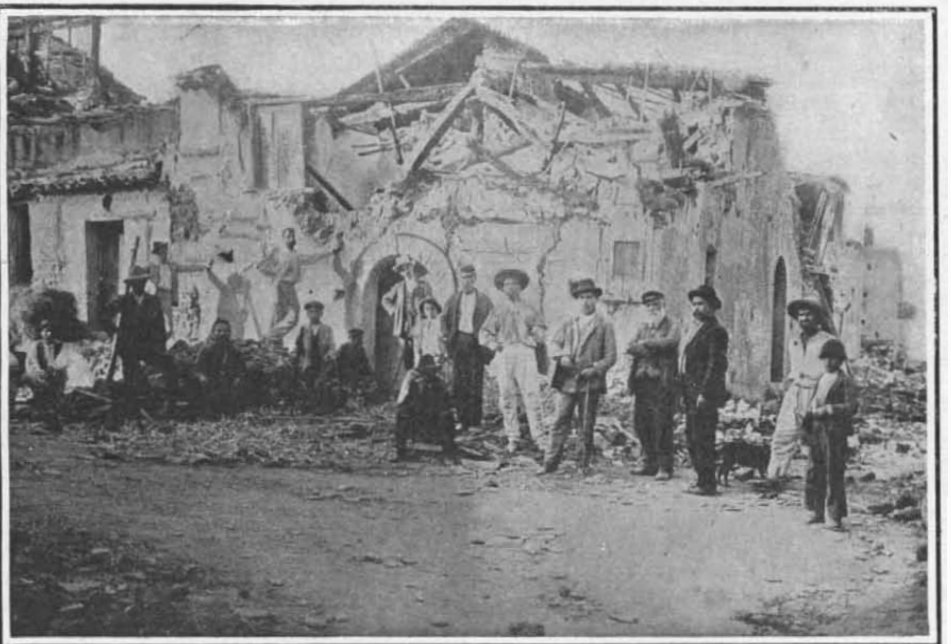

Copyrighted 1909 by Press Publishing Co.

English sailors aiding in rescue work.

A typical scene in ruined Calabria.



Searching the ruins of Palmi.

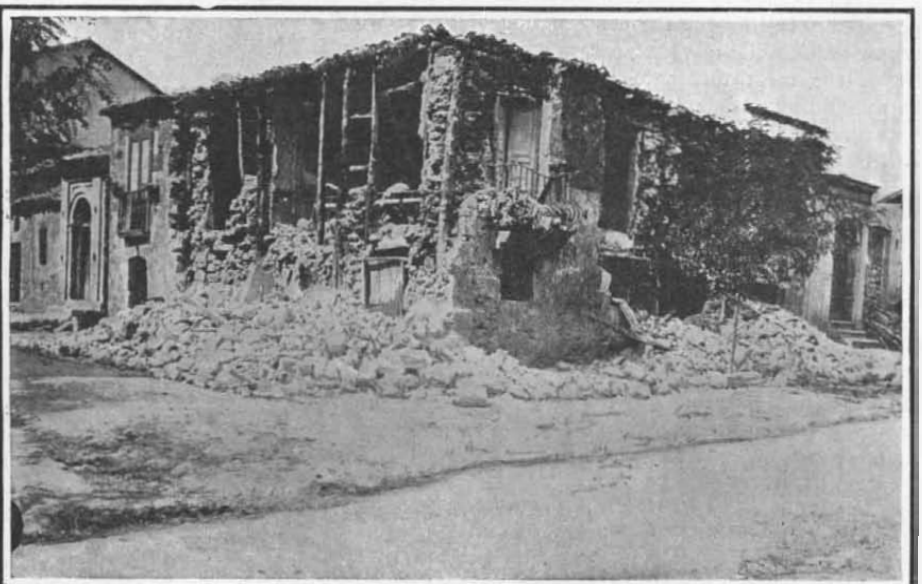

The ruins of a typical frail Calabrian house.



A ruined house near Bagnara.



Soldiers razing walls in danger of falling.

## SCIENTIFIC AMERICAN

ESTABLISHED 1845

MUNN &amp; CO. - - Editors and Proprietors

Published Weekly at  
No. 361 Broadway, New YorkCHARLES ALLEN MUNN, President,  
361 Broadway, New York.FREDERICK CONVERSE BEACH, Sec'y and Treas.  
361 Broadway, New York.

## TERMS TO SUBSCRIBERS.

One copy, one year, for the United States or Mexico ..... \$3.00  
 One copy, one year, for Canada ..... 3.75  
 One copy, one year, for any foreign country, postage prepaid, lbs. 6d. 4.50

## THE SCIENTIFIC AMERICAN PUBLICATIONS.

Scientific American (established 1845) ..... \$3.00 a year  
 Scientific American Supplement (established 1876) ..... 5.00 "  
 American Homes and Gardens ..... 3.00 "  
 Scientific American Export Edition (established 1878) ..... 3.00 "  
 The combined subscription rates and rates to foreign countries, including Canada, will be furnished upon application.  
 Remit by postal or express money order, or by bank draft or check.  
 MUNN & CO., 361 Broadway, New York.

NEW YORK, SATURDAY, JANUARY 23, 1909.

The Editor is always glad to receive for examination illustrated articles on subjects of timely interest. If the photographs are sharp, the articles short, and the facts authentic, the contributions will receive special attention. Accepted articles will be paid for at regular space rates.

## THE NAVAL PROGRAMME FOR 1909.

The programme of the Navy Department, which received the indorsement of the President, calls for the expenditure of \$75,000,000 in the construction of thirty new ships, including four first-class battleships, or double the number of battleships that Congress was disposed to build, each year, as part of a continuous naval programme. The House Naval Committee has cut down the proposed expenditure by nearly two-thirds, to a total of \$29,000,000; and the increase of the navy, as now proposed, will include fifteen new ships, namely, two 26,000-ton battleships, five torpedo-boat destroyers, four submarine boats, one sub-surface torpedo boat, and three colliers.

The disposition of the last Congress to commit itself, as far as battleships are concerned, to a continuous programme, calling for the construction of two of the largest of this class every year, was considered to be one of the most fortunate events in the history of the upbuilding of our modern navy. If it be adhered to, we shall have no difficulty in maintaining our position as the second most powerful navy in the world; and it would certainly seem to be wiser to encourage Congress in holding to a continuous programme of this character, rather than go back to the old haphazard methods of earlier years. The two battleships will be the largest ever laid down by several thousand tons. Their displacement will be 26,000 tons; and they will carry twelve 12-inch, 50-caliber guns in six turrets, all placed on the center line of the ship. If the middle pair of turrets be placed *en echelon*, or diagonally, across the vessel, the new ship will be capable of directing a fire of twelve heavy guns on each broadside and eight ahead and astern. This will be a more powerful fire than that of any ship at present planned. The new German battleships, it is true, can concentrate the same number of heavy guns in the directions named; but as these are 11-inch pieces, of less caliber-length, their fire will be of far less power than that of the proposed battleships.

We have one fault to find with the Senate recommendation, and that is that the provision for three colliers is altogether too scanty. So serious do we consider the lack of colliers in the crippling effect which it would have upon our naval operations, that we would prefer to see the torpedo boats and submarines cut out altogether, and the balance of the appropriation, after providing for the two battleships, devoted to the immediate construction of eight or nine colliers, of the new "Vestal" and "Prometheus" type, each of which can carry 6,000 tons of coal at a sea speed of 16 knots an hour.

## OUR DECADENT MERCHANT MARINE.

The signs of the steady decadence of our merchant marine are written so clearly, that he who runs may read. Those of us who a few years ago were hopeful that an era of rapid upbuilding had begun, and that the United States was in a fair way to win back something of that prestige which was hers before the ravages of the civil war swept our magnificent fleet of sailing ships from the high seas, must view with regret, even if it was not unexpected, the abandonment of the Eastern Shipyard at New London, in which Mr. James J. Hill, by the construction of the then two largest steamers in the world, endeavored to establish a strong hold on the Oriental trade, and incidentally assist in winning back for our merchant marine something of its one-time prestige.

In those days Mr. Hill firmly believed that American ships, built in American yards, and embodying the many well-known advantages which accrue to a freight steamer of the largest size, could be run profitably

without any assistance from the government; and we may be satisfied that the conduct of the new venture was marked by those excellent business methods, which have rendered the transcontinental road with which the steamships were associated such a conspicuous success.

One of these fine vessels was lost off the coast of Japan, it is true; but it is also true that the vessel was insured, and hence the failure of Mr. Hill to take any steps toward replacing the ship must be regarded as highly significant. Although the sister ship "Minnesota" is still running in the Pacific trade, the fact that she is generally understood to be for sale, coupled with the recent dismantling and abandonment of the yards where she was built, must be taken as a tacit acknowledgment of the failure of an enterprise upon which so many high hopes were centered.

The lesson which is written so clearly upon this abandoned New England shipyard is not new. Rather it is one among many accumulating proofs of the fact that, because of the greater cost of building and running American ships, it is hopeless for this country to try to establish a merchant marine in the face of keen foreign competition, unless some measure of aid be afforded by the government.

In seeking for government aid, the shipping interests do not ask that any new policy be established. They simply request that the principle of protecting young industries, until they have developed to a point at which they are able to meet foreign competition unaided, be extended to the merchant marine. It is confidently believed that if government aid were extended in some form or other, preferably as compensation for carrying the mails, the resulting increase in the shipbuilding business would be so great, as ultimately to place the shipping industry in a position to meet foreign competition unaided. When that stage of development approaches the subsidies could be gradually reduced, and finally withdrawn. Expectations of the successful working of a system of this kind are strongly warranted by the phenomenal development, during the past two decades, of some of our leading industries, and notably that concerned in the manufacture of steel. The recent statement of our leading ironmaster, that the steel industry in this country is to-day strong enough to hold its own unaided against free European competition, is fresh in our minds; and we confidently believe that the extension of a well-considered measure of government aid to our merchant marine would, in the course of time, enable this country to win back something of its former proud position as the leading maritime nation of the world.

Postmaster-General Meyer, speaking of the ocean mail service, says that with the exception of our service to Jamaica, Cuba, and the Atlantic ports of Mexico, which has prospered under the act of March 3, 1891, our mails to Central and South America, West Indies, Australia, and the Orient, are almost wholly dependent on foreign steamers, over which we have no jurisdiction. He further notes that within two years the number of American steamers crossing the Pacific and available for carrying the mails has been reduced more than one-half. Last year, the Post Office Department recommended, and the Senate by a practically unanimous vote passed, a bill which provides that the compensation of \$4 a mile, now allowed to 20-knot transatlantic American mail steamers, be allowed also to American steamers of not less than 16 knots speed on routes of 4,000 miles or more to South America, the Philippines, Japan, China, and Australasia. It would require several years to establish the new mail routes which are contemplated in the bill, since most of the fast steamers would have to be built. The passage of the bill would impose no large immediate expenditure; whereas the creation of new mail lines would promote trade, stimulate shipbuilding, and greatly strengthen the auxiliary naval forces of the government.

## THE TRAFFIC OF A GREAT CITY.

Not many of us were prepared for the really stupendous figures of the passenger traffic of New York city, which are made public in the report, for 1908, of that most admirable and efficient body known as the Public Service Commission. It appears that the surface, elevated, and subway companies in New York carry annually over 1,300,000,000 passengers. What these figures mean will be better understood, when it is stated that they are over 66 per cent greater than the total number of passengers carried in the same year on all the steam railroads of the country combined. The total capitalization of these transportation companies is over \$533,000,000, and they derive annually from the passengers carried over \$62,000,000. Incidentally, it may be mentioned that the capitalization of New York's gas and electric companies is over \$386,000,000, and that they sell, annually, 32,000,000,000 cubic feet of gas; which amount is more than twenty per cent of the entire gas production in the United States. Moreover, the income from the sale of electricity alone in the city exceeds \$20,000,000.

By the close of 1908 the city had expended over \$50,000,000 in the construction of subways; and an additional \$100,000,000 will be necessary to build the Broadway-Lexington Avenue line, the loop lines connecting the Williamsburg and Manhattan bridges, the line across Manhattan below Canal Street in Manhattan, and the Fourth Avenue line in Brooklyn.

So much confusion exists in the public mind as to the exact status of the proposed new construction, that the following information from the report will be of no little interest. In the first place, the Commission declined the proposal of the Interborough Company to build a road by way of the new Manhattan Bridge from Flatbush Avenue, Brooklyn, to the Third Avenue Elevated Road in Manhattan, preferring instead to proceed with the construction of the Fourth Avenue Subway in Brooklyn. The construction of this line, however, has been held up by a taxpayer's injunction, and the matter is still in the courts. The Broadway-Lexington Avenue Subway has been delayed by the difficulty experienced in getting the consent of property owners. A decision of the Appellate Division rendered last month has cleared the way for the Board to proceed with the construction, and it hopes shortly to adopt the final plan of its chief engineer. Plans are also being prepared for a subway to run below Canal Street, from the Manhattan Bridge to the Hudson River, with provision for a rail connection at the intersection at Broadway with the proposed Broadway-Lexington Avenue line. The Subway loop connecting the Williamsburg and Brooklyn bridges is being pushed to completion, except on that section which passes below the new Municipal Building adjoining the Brooklyn Bridge Terminal, where it will be necessary to lay the building foundations before completing the Subway. The refusal of the Utilities Board to purchase the Steinway tunnel from the Interborough Company was due to the objection, among many others, that the contract for operation proposed by the Interborough would have cost the city some \$350,000 a year.

The suggested improvements in the operation of the existing subways, made by Bion J. Arnold, are being followed in two particulars. First, with a view to facilitating the loading and unloading of trains, several new cars are under construction, which will be provided with a pair of doors at each end of the car, one of each pair being for ingress and the other for egress; and it is expected that some of these cars will shortly be placed in operation. Unless some unforeseen difficulties develop, it seems to us that the new cars should result in a considerable acceleration of the train service, due to the cutting down of the time of stops at stations. The new signal system proposed by Arnold, which permits express trains to be run under shorter headway, has proved so successful at the greatly congested 96th Street station, that the company is planning to install it throughout the line. Another important improvement is the alteration of the Bowling Green station to permit of a service of shuttle trains between Bowling Green and South Ferry, with a view to allowing all express trains to be run through to Brooklyn.

Most commendable has been the work of the Commission in gathering careful statistics of accidents and fatalities on all transportation lines. The total number of accidents has reached during the year the appalling total of 50,000, in which no less than 600 lives have been lost. Impelled by these statistics, the Commission conducted a series of extensive competitive tests of fenders and wheel guards, which were thrown open to all manufacturers in this country and abroad. We sincerely hope that these tests will shortly result in the enforced adoption of some satisfactory life and limb saving device on all the street railways of this city.

Sir James Dewar having succeeded, by the use of the radiometer, in detecting a gas pressure of the fifty-millionth of an atmosphere, and having definitely detected by this means the helium produced in a few hours from about ten milligrammes of radium bromide, has undertaken the direct measurement of the helium produced by radium. For this purpose he employed 70 milligrammes of radium bromide belonging to the Royal Society, which had been used by Dr. Thorpe in his recent determination of the atomic weight of radium. The apparatus employed for measuring the helium consisted of a McCleod gage in which no rubber joints were used, together with ingenious arrangements for exhausting the apparatus. Any traces of adventitious gases were absorbed by an attached bulb containing charcoal and cooled in liquid air. In one instance the pressure registered at the start of the experiment was 0.000044 milligramme. The radium salt was occasionally heated and the pressure of the helium was determined from time to time. A steadily maintained helium increment was obtained of approximately 0.37 cubic milligramme per gramme of radium per day. This result agrees very closely with Rutherford's theoretical calculation, which gives about 0.3 cubic millimeter per day.

## ENGINEERING.

State Forest Commissioner Whipple estimates the forest fire losses in New York State alone, during the past year, at nearly \$800,000. Of 700 fires reported, 90 are attributed to hunters, and nearly 400 to railroad locomotives. A total area of 177,476 acres was burned over, of which over 50,000 acres were State lands.

It is estimated that in the Borough of Manhattan there are about 10,000 passenger elevators and 12,000 elevators for freight service. In twenty-six office buildings of eighteen stories and over, with a rentable area of 116 acres, there are 231 elevators, which travel between 4,000 and 5,000 miles of vertical distance each day, and carry 615,000 passengers. There are 8,000 elevators in office buildings alone.

In the closing days of last year an actual start was made in the manufacture of steel at the new city of Gary, Ind., which has been built by the United States Steel Corporation on the shores of Lake Michigan, a few miles to the east of Chicago. This important step was signaled when blast furnace No. 12 was blown in. The mills embody the very latest practice in the art of steel making; and the estimated cost of the plant as projected is \$25,000,000. If the plans of the company are carried out, Gary must become one of the greatest centers of the iron and steel industry in the world.

The New York, New Haven & Hartford Company have asked permission from the Public Service Commission to electrify the branch line of their system from New Rochelle to the Harlem River. This line has recently been equipped with six tracks; and it is believed that the proposal to electrify the road is part of a scheme on the part of the New Haven Company to obtain an independent line into New York city by way of the new bridge of the Connecting Railroad at Hell Gate, a line through Long Island City, and a tunnel beneath the East River.

Those naval specialists who are perturbed at the growth of what they are pleased to call the "speed mania," will be startled to learn that the latest battleship cruiser to be laid down for the British navy is designed for a contract speed of 28 knots. The sister ships were designed for 25 knots and made, on trial, from 27 to 28 knots. Therefore, it is not improbable that, in two or three years' time, we shall be confronted with the spectacle of an 18,000-ton warship that is able to transport her battery of eight 12-inch guns at a speed, for a short dash, of 30 knots and a sustained speed of over 27 knots.

The German auxiliary sailing ship "R. C. Rickmers," the largest sailing ship afloat, has proved that the days of the profitable square-rigger, if she only have an auxiliary to help her through the calms, are by no means over. During her two and a half years of active service, she has covered over 100,000 miles, and her earnings have been about \$2.25 for every mile of that distance. This noble ship, 441 feet in length, formed the subject of a front-page illustration in our issue of October 6, 1906.

All the vessels of our battleship fleet are to be equipped with the new spiral latticework military mast of the kind illustrated in our issue of November 14, 1908. Before this work is commenced, the government intends to make a seagoing test, to determine how much vibration this type of mast will be subjected to under ordinary conditions at sea. The test will be carried out on the new battleships "Idaho" and "Mississippi," and will be in charge of Naval Constructor Robinson, who was chosen to accompany the Atlantic fleet on its cruise from Hampton Roads to San Francisco.

According to the United States consul at Chemnitz, the German government is offering prizes for an effective method of combating the destructive effects of factory gases upon vegetation. Damage to agriculture and to the extensive forests by the smoke of the numerous factories is becoming every year more marked. Hence the Saxon Ministry of Finance is offering a prize of \$2,400 to the inventor who provides the best preventive of the injuries now due to sulphurous acid and other acid vapors in factory smoke, and to the effect of the harmful products of the combustion of bituminous coal. An additional prize of \$500 will be given for the best compendium of the literature on the subject.

In spite of the serious depression of the past year, the figures for new railroad construction show that in 1908 there was built a total of 3,214 miles of new road. This is a considerable falling off from 1907, when 5,212 miles were constructed; but it is only 600 miles less than the total for 1904, and exceeds by over 100 per cent the figures for 1895, when only 1,428 miles of new road were constructed. The statistics of new car construction show that as compared with 1907, when over 284,000 freight cars were built, and 5,457 passenger cars, there is an enormous falling off, the totals for 1908 being respectively 76,555 freight and 1,716 passenger cars.

## ELECTRICITY.

An international electrical exhibition will be held at Brescia, Italy. The exhibits will be divided into fourteen groups covering all classes of electrical application.

It is reported that the Pennsylvania Railroad, which is now investigating the results attained by the use of telephones on western railroads, is favorably impressed, and may adopt this system of train dispatching in place of the telegraph.

One of the latest electrical novelties for household use is the electrical razor. The form of the razor is similar to the well-known safety type; but the razor is given a vibratory movement by means of a rotary eccentric in the handle of the device. This motion is sufficient to cut the beard as the razor is drawn across the face.

A new material has recently been produced in the electric furnace to take the place of platinum in electric cooking and heating devices. The new product is called *silundum*, and is produced by subjecting carbon to the vapor of silicon. The result is a silicified carbon which is similar to silicon carbide and has many of the same properties. It resists temperatures of 1,600 deg. C. and does not oxidize, nor is it affected by acids. As a conductor of electricity its resistance is several times that of carbon.

A sensitive mono-telephone has been described by Henry Abraham before the French Academy of Science. In place of the ordinary diaphragm an armature of sheet iron is supported on two steel wires stretched tightly across the magnet of the telephone. The armature is of such size that it barely covers the magnet. The tone produced by the armature may be varied by adjusting the tension of the wire. The instrument is thus made as sensitive as the ordinary receiver, but is particularly sensitive to frequencies corresponding to the natural sound period of the armature. The instrument is particularly designed for use in wireless telegraphy on systems tuned to a certain wave length.

The town of St. Albans, near London, is using a novel system for generating electricity. The generating station which has just been completed uses no fuel except the town refuse. The refuse is burnt in a destructor plant capable of consuming from 50 to 60 tons per day of eighteen hours. The combustion chambers are provided with large furnace doors to permit of the introduction of large articles, such as mattresses, animal carcasses, and the like. The plant is equipped with two engines each operating two 75-kilowatt direct-current generators. The current is generated at 230 volts on either side of a 460-volt three-wire system. The battery room of the plant contains 268 cells with a capacity of over 1,000 ampere hours at a 10-hour discharge rate.

A novel single-truck electric car is being used on a small Pennsylvania road in which the monitor roof is eliminated, giving the car a very peculiar squat appearance. The advantages gained by eliminating the monitor roof are that more head-room is provided inside the car and the sashes of the windows may be raised much higher than usual. A special ventilating system is provided which does away with the ordinary ventilators of monitor roofs. The truck of the car is peculiar, in that it supports the car body at each end by means of bolsters. The bolsters are made up of heavy elliptical springs which do away with side sway and are stiff enough to prevent the car from lurching and lunging with every little irregularity in the track. The car is equipped with a hydraulic brake. The motorman applies the brake by oscillating a lever back and forth several times to pump water into the brake cylinders. The brakes are released by pressing the lever against a valve.

The following record of the energy of a sal-ammoniac battery has been sent us by the Rev. William F. Rigge, S. J., of Creighton University: Two ordinary sal-ammoniac cells operate an electric dial from a master clock. The cells are quart size. The carbons are cylindrical, with a zinc rod in the middle. Half a pint of loosely-packed powdered sal-ammoniac is supplied to each cell with as much water as the jar will hold. The circuit is closed one second every minute. Under these conditions it was found that the zincs lasted about a year, and the solution required renewal after an average period of two years and two months. The resistance of the dial magnet is 16 ohms, of the line 2 ohms, and of the battery 1 ohm. The electro-motive force of the two cells in series is 3 volts, thus furnishing 3/19 of an ampere. As the circuit was closed one second every minute, the battery was in operation for 24 minutes each day, and for 316 hours in the two years and two months. This would mean an active duration of 13 1/6 days, or nearly two weeks, if the current could be supplied continuously. The life of these sal-ammoniac cells was therefore  $316 \times 3/19 =$  very nearly 50 ampere hours.

## SCIENCE.

J. Bouma and S. Berend produce a sugar-free milk preparation according to a German patent by precipitating the casein with carbon dioxide in the presence of monosodium phosphate. This salt has an acid reaction, and the product is amphoteric in reaction. Hitherto by precipitation with carbon dioxide it was impossible to produce a neutral preparation; the product was invariably alkaline.

Genuine Jamaica rum can be distinguished from its imitations and all other spirits by means of the absolutely characteristic ingredient which is the chief source of its peculiar odor. This ingredient is not an ester, an aldehyde, or a ketone. It possesses the character of an essential oil and is probably related to the terpenes. Jamaica rum contains a second characteristic ingredient, which smells somewhat like turpentine, but this is less conspicuous than the first, by means of which the chemist can often detect even the adulteration of genuine Jamaica with imitation rum.

From experiments on dogs Faust had concluded that the comparative immunity against morphine which follows from its habitual use, is not due to the tissues becoming accustomed to the drug, but to an increasing capacity of the organism for destroying the poison. This view has recently been confirmed by Rübamen, who showed that immune rats actually do break down the morphine in their system more rapidly than the normal rats. However, it appears that the immunity must be due to two causes: first, as stated above, to an increased capacity for destroying the poison in the system, and secondly, to a cellular immunity, for within the first hour after injection a large amount of the poison still circulates in the body, without affecting the individual.

The Carnegie Institution of Washington has awarded a contract for the construction of a craft for the magnetic survey. She is to be constructed without the use of iron or steel or any other magnetic metal. The purpose of the Institution is to make with her an accurate magnetic study of all the oceans. The propelling engines, machinery, and other parts of metal on the craft will be chiefly bronze. Manganese metal and gun metal will also be employed. Every bolt, nail, bar, and brace in the vessel will be of this material. All the machinery will be of bronze, and the anchors as well. There is some doubt as to whether the crank shaft of the engine can be constructed of bronze. The SCIENTIFIC AMERICAN hopes to publish an exhaustive account of this non-magnetic craft in the coming spring.

The astronomers of antiquity knew how to predict eclipses of the moon, which follow one another in regular succession and are visible at one time to all the inhabitants of one hemisphere. Solar eclipses also occur in regular order; in 223 lunar months there are in general 29 eclipses of the moon and 41 of the sun. But the latter are in each case visible only over a restricted portion of the globe, and their occurrence at any particular point is subject to somewhat complicated laws, with which the ancients were not familiar. From a study of eclipses which occurred in past ages, P. H. Cowell has reached the conclusion that the period of revolution of the earth, in other words the length of the year, has decreased within historical times. This result has been confirmed by Crommelin. The determination of the time of eclipses in the past is a valuable tool in historical research, in fixing the date of important events and epochs. Thus Mr. King has calculated that a total eclipse took place at Babylon in 1062 B. C. Another date thus fixed is October 6, 1241, on which Mr. Crommelin has shown that a total eclipse took place.

When the Japanese army evacuated Manchuria it became necessary to disinfect very rapidly a great number of garments, many of which were made of fur, while the troops were taking a bath preparatory to embarking on the transports, which were to convey them to Japan. The ordinary processes were rejected as too slow and the following expeditious method was substituted, with excellent results: The garments were hung, or placed on racks in rooms, into which steam at the pressure of six atmospheres was forced until the temperature rose to 100 deg. F. At the same time the air of the room was pumped out through an aperture near the floor, in order to produce a lively circulation of steam and a rapid saturation of the garments. After twenty minutes' steaming, a spray of formic aldehyde was thrown into the entering current of steam, and the steaming was continued for ten minutes longer. The walls of the disinfecting rooms were only six or seven feet high, and were so constructed as to minimize loss of heat by conduction. The capacities of the rooms ranged from 1,000 to 1,600 cubic feet. About one fluid ounce of the commercial 40 per cent formol solution was used for each 50 cubic feet of space, the solution being reduced to spray and vapor in about one minute. The efficacy of the process, even when applied to five layers of fabric piled together, was proved by numerous bacteriological tests.

### THE SUBMARINE MINE.

BY GEORGE FORREST.

The first official recognition of torpedoes, or mines as they are now called, was in 1869, when Congress added submarine mining to the work of the Engineer Corps of the army. About 1871 Gen. Abbot commenced a series of experiments at Willets Point, N. Y., which led to the adoption of the system used to protect our harbors in 1898. There is little doubt that the knowledge of our waters being well mined had something to do with keeping Admiral Cervera from paying us a visit then, as our gun defenses were notoriously weak.

The mine is simply a hollow sphere of steel, 32 inches in diameter. At the top is a ring for handling, and at the bottom a detachable cap. In the interior of this cap a watertight joint is made, connecting the cable to the wire leading into the firing plug. The anchor most in use is one weighing 500 pounds, the connection being a wire mooring rope, which is cut 10 feet shorter than the distance from the bottom to the surface of the water at low tide. The charge consists of 100 pounds of dynamite No. 1.

Mines are now planted in what is known as "grand groups," which consist of twenty-one mines in groups of three. Some distance in the rear of the line of mines there lies on the bottom of the bay a grand junction box, from which seven cables spread, each leading to a triple junction box, which in turn controls its small group of three mines. From the grand junction box leads the multiple cable also, which winds its way to the switchboard connection in the operating room ashore.

The first movement in planting a grand group is to locate the position of the grand junction box. Observations are taken with the range instruments in the fire commander's tower. Then the exact range and position of the mine field having been determined, two men with signal flags are stationed on opposite shores. A small boat is now sent out with a light anchor attached to a buoy. The progress of this boat is directed by the flags, and at the proper signal the lashings are cut, and the anchor drops to the bottom. We now have a buoy on the surface of the water, which marks temporarily the position of the grand junction box.

While this work is going on, the powerful steel tug known as the mine planter has been held in readiness near the shore. It now steams over to the marking buoy, and replaces the light anchor with one weighing 500 pounds. Here a small boat is moored, and the end of a measuring line is passed to the man in charge. Quickly the planter steams straightaway to the front, and at 100 feet drops another anchor. This is the position of the first triple junction box, directly under the line of mines. There are seven of these triple junction boxes to plant, 300 feet apart and directly across the channel. The small boat now moves over to this last anchor, and takes the end of another measuring line from the planter. This line has a red

mark every 280 feet, and a black one every 300 feet. The planter steams straight to the left, paying out the line as she goes, and as the warning mark—red—passes, the officer in charge commands "Prepare to trip." At the word "trip" the anchor with attached buoy is dropped overboard, and thus the position of the second triple junction box is marked on the sur-

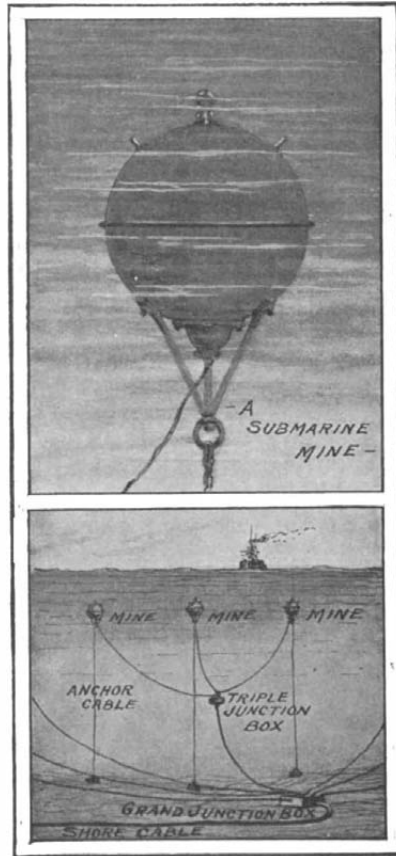

This mine is a hollow steel sphere 32 inches in diameter containing 100 pounds of dynamite. It is detonated electrically or on contact with a ship.

#### Submarine mine and details of wiring.

face of the water. Continuing the work, we have indicated by buoys the position of the seven triple junction boxes, in the center of which, 100 feet in the rear, is the grand junction box.

We are now ready for our cables, which are of two kinds, single, and multiple or seven core. This core, which is of copper, is covered with a layer of rubber tape, then two wrappings of jute, and finally an armor of steel wires. The first to be laid is the multiple cable, connecting the grand junction box with the operating room ashore. We already have a small boat out containing the grand junction box at its marking buoy. From the dock the planter takes the reel of multiple

cable aboard, and fastens it to a specially constructed hydraulic jack. A rope is passed ashore through a block fastened to any convenient tree and back to the windlass. By hauling on this rope, the end of the cable is pulled ashore and fastened. Proceeding to the small boat containing the grand junction box, the planter pays out the cable as it goes. Upon arriving, the cable is cut and handed over to the men in the small boat, who proceed to make of the end a "Turk's head." This Turk's head is constructed by slipping over the end of the cable an iron snug-fitting ring or collar. The armor wires are then bent back over this collar about 15 inches. Lashings of heavy twine are used to hold these wires in place. This allows about 15 inches of the core to project for connections inside the grand junction box. The men now place the end of the cable in its proper socket in the box. It is then clamped down just behind the collar by screwing home the bolts. This prevents any possibility of the cable being twisted out of its socket by the heavy currents and constant wave movement of the buoyant mine. Later, when the seven triple junction box cables are each arranged in their proper sockets, and the watertight connections are all made with the multiple cable inside the box, the waterproof compound is poured over all; the cover bolted down, and all is ready for dropping the box overboard.

But we have not come to that yet, as there is plenty of work still to be done. Returning to the dock, the planter takes aboard the branch cables used for connecting the triple junction boxes with the grand junction box. They are coiled in a large figure eight, tagged with their proper number, and placed conveniently on deck. These cables are numbered, because, as will be seen by referring to the sketch, they are necessarily of different lengths. Steaming swiftly to the anchored open boats, the end of a cable is first passed to the men in the grand junction box boat. Then moving over to the triple junction box boat, the planter's crew hands out the other end. The crews in both small boats are now very busy making Turk's heads, placing them in proper sockets, and making inside box connections as above described. Repeating this work, we have the entire grand group of seven triple junction boxes connected with the grand junction box.

While all this work is going on, another detachment ashore has been loading the mines, cutting the mine cables, and preparing all for planting. All being ready, the twenty-one mines are placed on board the planter. While it is steaming out to the mine field, the men arrange the cables along the decks and hang a mine with its cable and anchor on each side of the boat. Once again a Turk's head end of a cable is passed to the men in the small triple junction box boat, but this time it is the mine cable. Again connections are made with the triple junction box as described. The mine end of the cable has already been connected in the mine

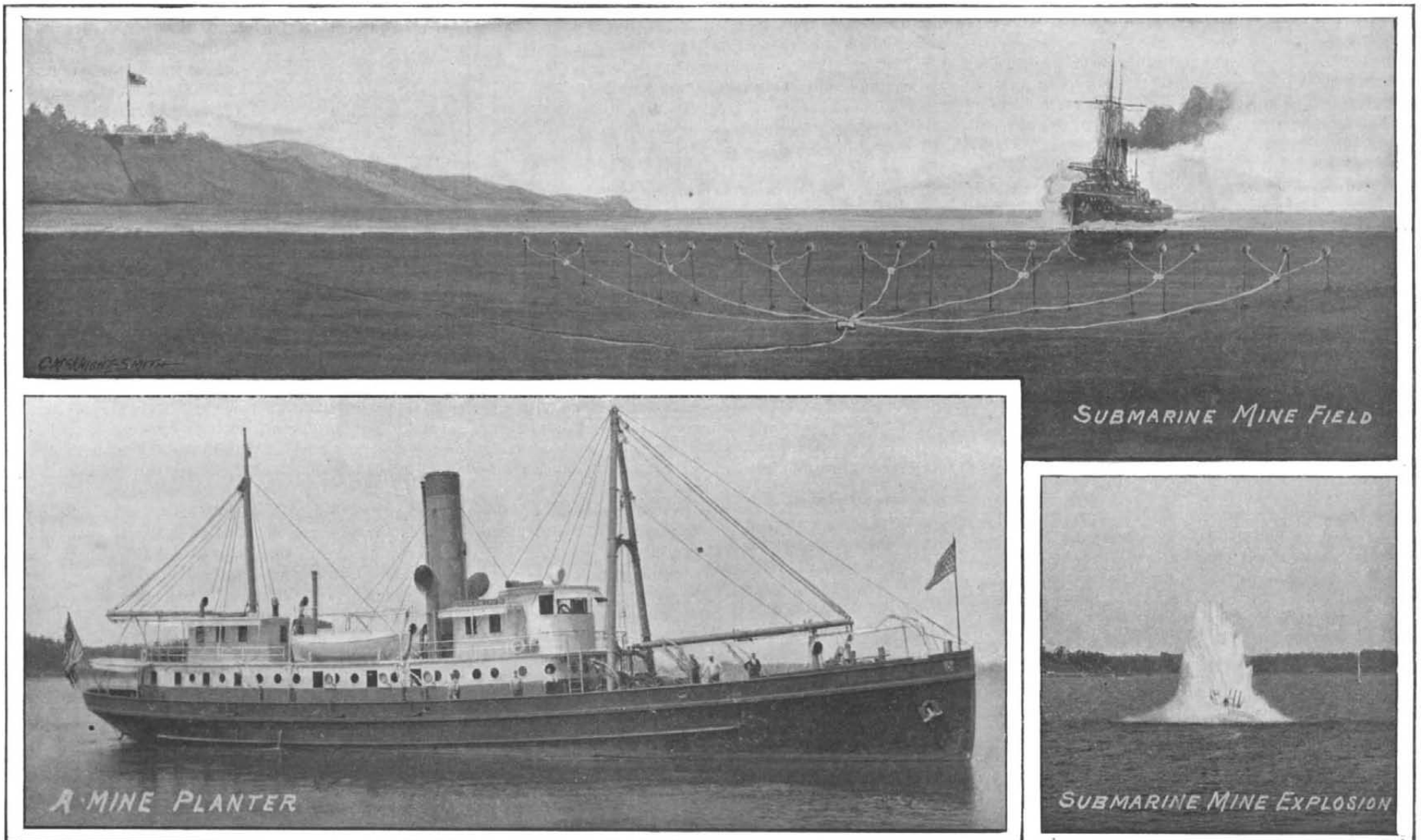

THE SYSTEM OF PLANTING SUBMARINE MINES FOR THE UNITED STATES COAST DEFENSE.

before loading on board the planter. Quickly the men in the small boat make their connections. Meanwhile the planter backs slowly away and drops the mine. The work so continues until the third mine of each group of three is dropped overboard. Then at a signal from the planter, the men in the small boat containing the triple junction box drop the box overboard. We have now planted one of the small groups of three mines with its triple junction box. After all have been so planted the signal is given, a last rigid inspection is taken, and overboard goes the grand junction box. It only remains to collect all buoys, and the grand group is ready for the enemy's fleet.

By an ingenious arrangement, one mine, three mines,

or the whole grand group can be fired at once, either from the operating room ashore or by contact with a ship, all at the will of the operator. For quick execution, reliability, and absolute destructive power, we do not believe the equal of the American submarine mine exists in the world.

**AEROPLANES AND MOTORS AT THE FIRST PARIS AERONAUTICAL SALON.**

The new aeronautic industry has already assumed such proportions in France, that the first Aeronautic Salon was held recently in the Grand Palais at Paris. The Salon was held in conjunction with an exhibition

of commercial motor vehicles, which also proved very interesting to the public.

In our illustrations this week we show some of the new aeroplanes which have recently been brought out in France, and several of which were exhibited at the Salon.

The aeroplane of greatest interest is the new double-surface Bleriot machine, shown herewith. Bleriot, it will be remembered, is one of the most thorough and daring experimenters in the art of aerial navigation. He has built numerous machines, among them several of the Langley following-plane type, with which he made successful flights. Latterly he has experimented with monoplanes, as the monoplane is a more advanced

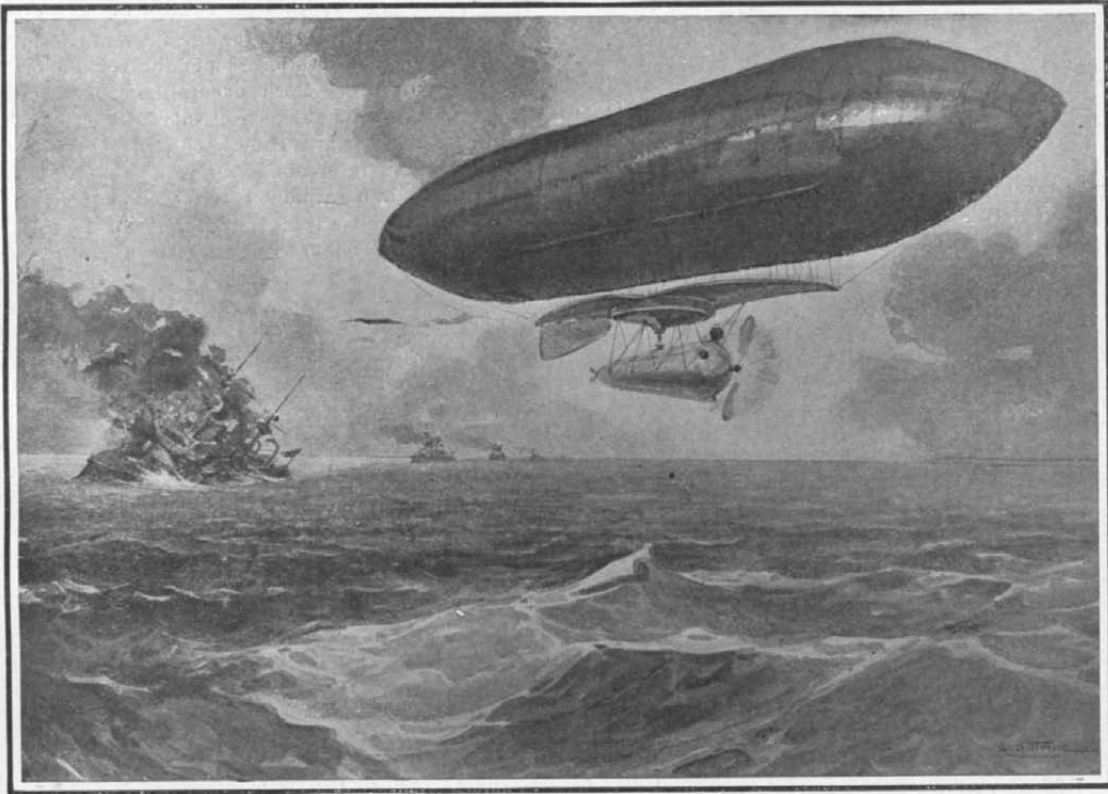

**An aerial torpedo dirigible attacking a warship at sea.**

In illustrating the use of a novel type of dirigible the artist has forgotten the vulnerability of this huge ship of the air.

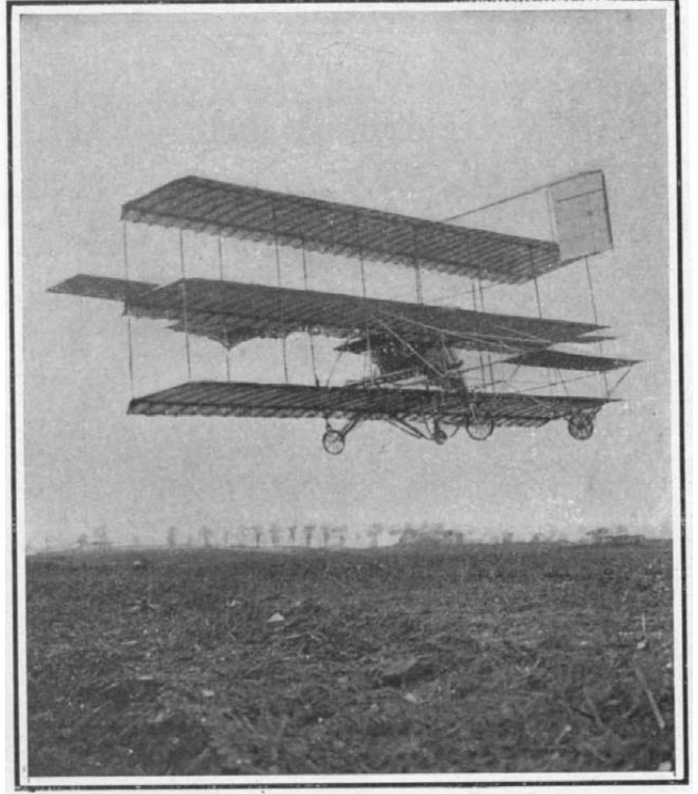

**The Vaniman triplane in flight.**

The vertical and horizontal rudders in front, the movable wing tips at the ends, and the stabilizing tail behind are all clearly shown in this photograph.



**Melvin Vaniman at the control levers of his three-deck aeroplane.**

The 4-cylinder motor and one blade of the propeller are seen back of the aviator. The radiator is also visible above the motor at the left.

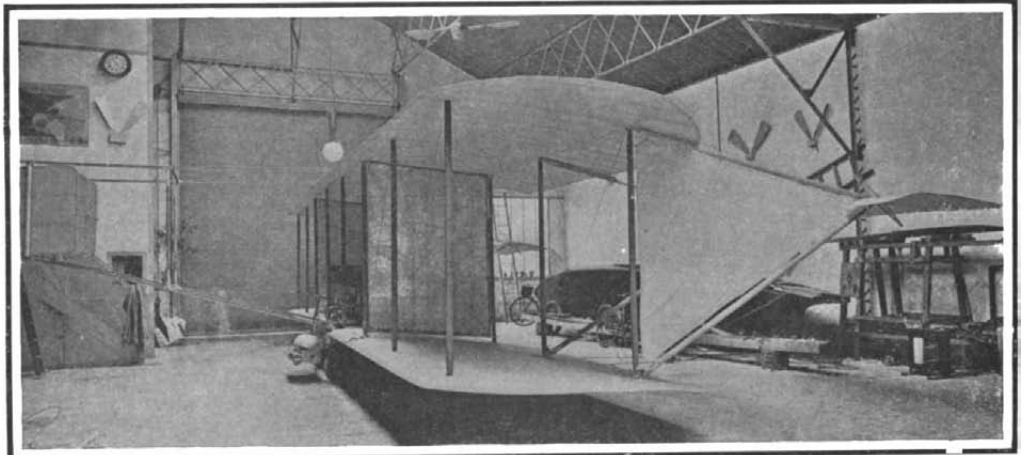

**End view of the new Bleriot two-surface aeroplane.**

The triple vertical rudders are seen in front (at the extreme left of the photograph) and the horizontal rudders on the end of the triangular partitions at the rear.

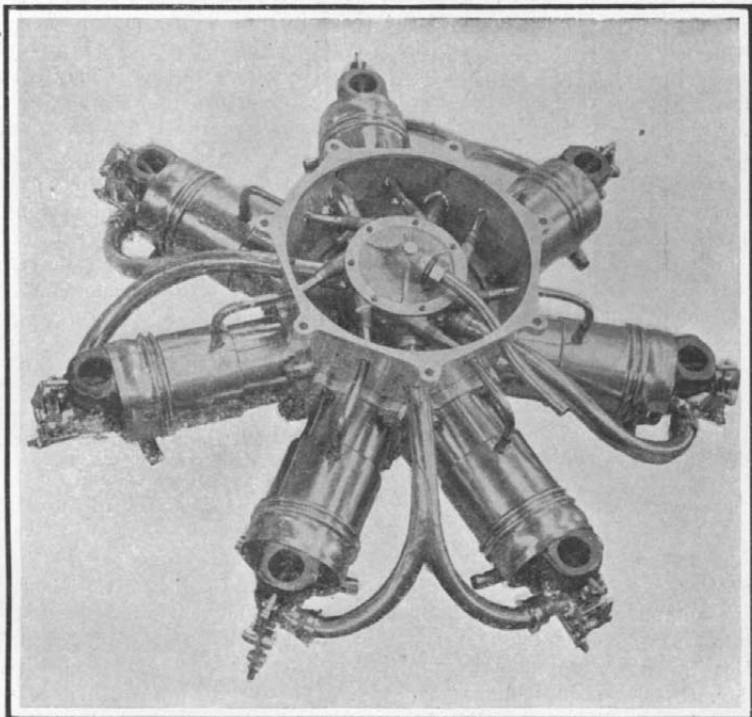

**The Clement-Bayard 7-cylinder aeronautic motor.**

This view shows the under side of the motor, the cover of the case being removed to show the pump.

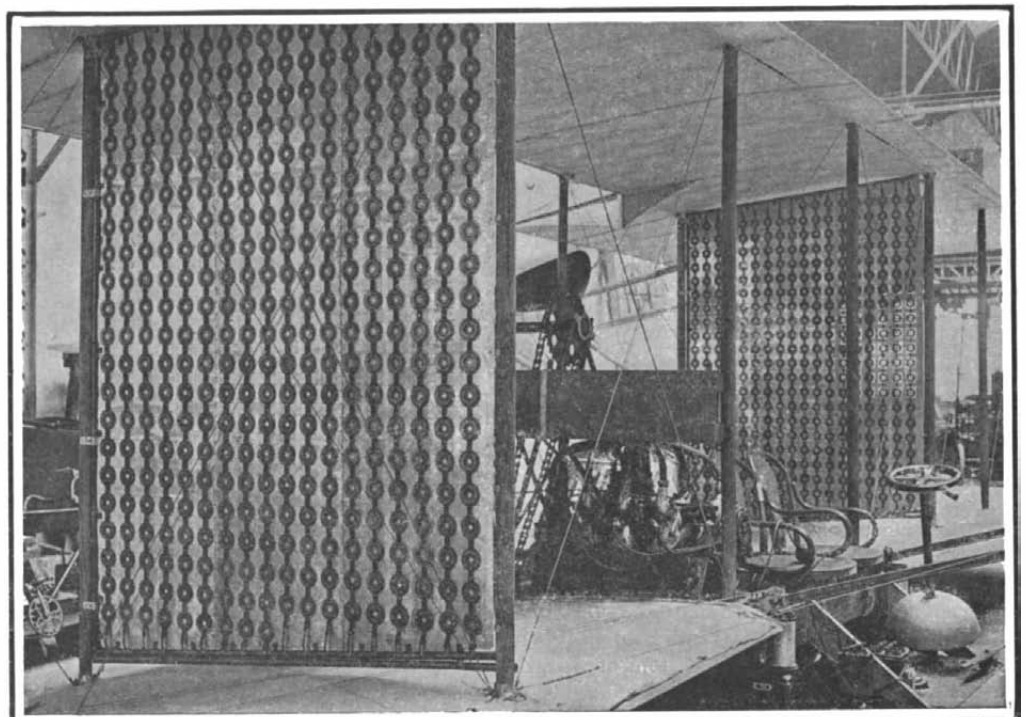

**Center of new Bleriot aeroplane, showing the motor, radiators, propeller, and steering wheel.**

The two seats for the aviator and one passenger are also to be seen at the front, as well as the driving chain extending from the motor to the propeller at the rear. Note also the cylindrical shock absorbers at the front edge.

type of machine, with which it is possible to obtain the highest speed. On October 31 he made a cross-country flight of about 18 miles, including two stops *en route*, with his monoplane. On November 4 this machine was demolished, and its dangerous character was again shown. Since then he has constructed a new double-surface machine much like the Wrights', yet differing from it in several main features. Chief of these is the replacement of the front horizontal rudder by triple vertical rudders, and the use of separate single-surface horizontal rudders behind the main planes at a distance of several feet. These rudders are carried upon triangular vertical trusses, the outermost of which are covered with cloth. The horizontal rudders, when rigged behind the planes as Bleriot has arranged them, will doubtless be less efficient than if they were in front. Nevertheless, the aviator proposes to sit in a comfortable chair on the front edge of the lower plane, and to steer and control his machine by means of an automobile type steering wheel and a single lever beneath it. The two horizontal rudders, of 8 square meters (86.11 square feet) each, are so connected that a movement of the lever inclines one upward and the other downward a like amount; while pushing forward or pulling backward the steering column causes both to act together for directing the machine upward or downward. Turning the steering wheel operates the triple vertical rudders for steering to one side or the other.

Thus Bleriot accomplishes with but two auxiliary horizontal pivoted surfaces—the same number as has the Wright aeroplane—what the Wrights have to warp the main planes to accomplish, i. e., the maintenance of the transverse stability, in addition to carrying out the main object of these auxiliary surfaces, namely, the directing of the machine up and down.

As Farman has found the use of vertical partitions connecting the main planes to be advantageous, M. Bleriot has placed one of these on each side of the center part of his new aeroplane, in addition to the triangular vertical portions extending back from the rear edge at the ends. The two central partitions, instead of being made merely of cloth, are, however, constructed of sheet aluminium, and made to serve as radiators for cooling the water used in the jackets of the motor. Applied to each surface of the sheet aluminium are a large number of rings of small-sized tubing, connected together by flexible pipes. The cooling water is forced through the large radiating surface thus formed, by a suitable centrifugal pump.

The motor which will first be used on this new aeroplane is a 50-horse-power Antoinette of the 8-cylinder V type. Later, a 100 horse-power 16-cylinder motor may be tried. The 3-meter (9.8-foot) 4-bladed propeller is placed at the rear of the main planes, which are notched at their center rear edges to allow the propeller to be brought farther forward and to be supported on the central rigid part of the structure. This propeller is driven at 480 R.P.M. by a chain from the motor crankshaft. There is a speed reduction of about 3 to 1 from the engine to the propeller. From his experience with his monoplanes, M. Bleriot evidently believes that the gyroscopic effect of this large 4-bladed propeller will not be sufficient to cause trouble with his new double-surface machine.

The main planes of the Bleriot machine have a spread of 12 meters (39.37 feet), and their width from front to back is  $2\frac{1}{2}$  meters (8.2 feet). The total supporting surface of the two planes is 60 square meters (645.83 square feet). The weight is given as 480 kilogrammes, or 1,058 pounds, but as M. Bleriot expects to be able to carry two or three passengers, this would make a total weight of from 1,200 to 1,650 pounds. Two passengers are to be carried on the front edge of the machine, and two on the rear. The total length from front to back is 8 meters (26 $\frac{1}{4}$  feet). The machine rests upon three very small wheels equipped with large pneumatic tires. On account of the small diameter of the wheels, the lower plane is quite close to the ground, and it will be necessary to alight on an even keel in order not to damage this plane.

The improvements that Bleriot has made upon a machine of the Wright type have caused this to assume a very businesslike appearance. The new machine has sufficiently large radiators to allow it to run for an indefinite period; and the only limit to the length of time it should be able to remain aloft, should be the amount of fuel that can be carried. The 50-horse-power 8-cylinder motor consumes much more fuel per hour than does the 4-cylinder, 25-horse-power motor of the Wright aeroplane, so that in this respect the Wrights doubtless still have a decided advantage. It has yet to be shown, too, whether the combined horizontal rudders and wing tips in the rear will be as efficient for maintaining the transverse equilibrium of the aeroplane as is the Wright system of warping the main surfaces. Bleriot has had considerable experience with movable wing tips upon his monoplanes, however, and he doubtless did not adopt this system without knowing that it would work fairly well.

Another new machine which has recently flown successfully in France is the three-decker of Melvin Vani-

man. This is not the first aeroplane of this type to be experimented with, but it is, we believe, the first one which has made a really successful flight. On December 18 last, above the parade ground at Issy-les-Moulineaux, it flew a distance of 150 meters (492 feet). Although the aeroplane is mounted upon four wheels, M. Vaniman nevertheless uses the Wright brothers' system of starting from rails; but in his case a track is laid for the aeroplane to run upon, instead of making use of a single rail and a special carriage. The aeroplane rose by its own power, and how well it behaved in the air can be seen from our illustration. The Vaniman three-decker has both its horizontal and vertical rudders placed well out in front. The horizontal rudder is about on a level with the middle plane, while the vertical rudder is placed between this plane and the upper one well out in front, and a tail with horizontal and vertical surfaces is placed on the same horizontal line at the rear. There are also auxiliary planes or wing tips at the ends of the middle plane, for the purpose of maintaining the transverse equilibrium. The machine is equipped with an 8-cylinder Antoinette motor of from 60 to 80 horse-power. The two-bladed propeller is direct-connected to the crankshaft. A pair of horizontal radiators are mounted on a level with the top of the motor, one on either side of it. The aviator sits on a seat arranged in front of the motor, and controls the rudders and equalizing planes by two levers. The distinctive feature of this aeroplane is the fact that the framework is constructed of steel tubing. It is the first successful French machine having its framework made of this material. The advantages of the triple-surface aeroplane consist chiefly in the shortening of the planes, and thus in the making of a less cumbersome machine. Compared with the Farman or the Wright aeroplane, Vaniman's machine is several feet shorter in width. As can be seen from the photograph, it is a very symmetrical and rigid appearing structure; and we have no doubt that before long a machine of this type will make successful and extended flights.

The motor which we illustrate is the new Clement-Bayard, 50-horse-power, 7-cylinder aeronautical engine, which has recently been brought out by the Clement firm. The seven cylinders, each of which is provided with a copper water jacket, are evenly spaced about the central crankcase, and have their connecting rods attached to a single crank. Our photograph shows the under side of the motor, which has a centrifugal pump attached to the lower end of its crankshaft and arranged in a casing, the cover of which is removed. This centrifugal pump forces water to the bottom of the water jacket of each cylinder, there being seven separate outlets from the pump for this purpose. Just above the pump there is an annular mixing chamber, from which four large pipes run to the cylinders. Three of these pipes are branched, so that they supply six of the cylinders, while the fourth one (shown at the right) supplies the seventh cylinder only. The carbureter is placed at one side of the casing, the pipe connecting it with the mixing chamber being seen within this casing, to the right of the uppermost cylinder in our illustration. The inlet and exhaust valves are mechanically operated by a rocker arm and single push rod for each pair of valves. The push rods are worked by a cam ring that is concentric with the crankshaft, and that is driven at half the speed of the latter through an idle lay shaft. A high-tension magneto is placed above the cylinders and is gear-driven from the crankshaft, while on the upper end of the lay shaft just mentioned there is a distributor for supplying current to the spark plugs.

The drawing which we reproduce shows the way in which naval warfare will yet be carried on, according to those most interested in the lighter-than-air type of aerial craft. The dirigible seen in the foreground has discharged a torpedo from its torpedo-shaped car with disastrous results to the warship. The particular feature of the dirigible shown in our illustration is the placing of the torpedo-shaped car quite close to the gas bag, and the suspending of this car from a sort of hot-air turbine, by which the car can be swung in any direction when it is desired to fire at the enemy. This dirigible is a recent French invention, which the enthusiastic inventor believes will soon revolutionize warfare on the sea.

Further particulars of the Paris Aeronautic Salon, together with photographs of some of the noteworthy machines there exhibited, will be found in the current issue of the SUPPLEMENT, which also contains a very good article upon aeroplane construction.

#### Cash Prizes for Aeroplane Flights in America

Cash prizes to the amount of \$1,200 for aeroplane flights were announced last week. The first to be offered was \$200 by the magazine *Aeronautics* for a flight of one-half kilometer. Subsequently Mr. C. F. Bishop, president of the Aero Club of America, offered four prizes of \$250 each to the first four aviators who fly one kilometer. The latter flights must be officially controlled and must be made by a machine that has never before flown this distance officially.

#### THE SCIENTIFIC ASPECT OF EARTHQUAKES AND VOLCANOES.

BY W. J. MURRAY.

The dreadful natural tragedy enacted at the extreme south of Italy and the eastern coast of Sicily cannot fail to awaken the heartfelt sympathy of the whole world for the ill-fated victims of probably one of, if not the most appallingly destructive earthquakes in the annals of seismic disturbances throughout the world. The latest accounts estimate the loss of life at 170,000 to 200,000 people, and it is much to be feared that the total number when fully ascertained may turn out in excess of these figures.

We surely have here the evidence that in the play of cosmic forces nature reckes little of consequences. The terrible catastrophe on the shores of the straits of Messina has as little interest for the universe at large as the destruction of a microscopic infusorium or of the smallest bacillus. Both events happen through the operation of a mechanical necessity which throughout nature takes no cognizance of sentient beings, their feelings and their interests.

That from the human point of view, earthquakes are an evil goes without saying; and the worst of it is that it is quite impossible to prevent them, and almost equally impossible to avoid them.

Earthquakes and volcanoes, while different in their localities and modes of manifestation, are undoubtedly due more or less to a common natural cause, viz., the gradual cooling, and consequent shrinking or contracting, of the earth's crust, taken together with the fact of the great body of intense heat in the interior of the earth. A very high temperature must exist at a depth of even a small fraction of the earth's radius. At the depth of say twenty miles, the heat is so great that the most refractory solids, whether minerals or metals, would at once yield if they could be subjected to such temperatures in our laboratories. But none of our experiments can tell us whether, under pressure of thousands of tons on the square inch, the application of any heat whatever would be adequate to convert solids into liquids. It is, therefore, doubtful whether the terms solids and liquids are at all applicable, as we understand them, to materials forming the interior of the earth. As to the immediate cause of earthquakes, there is considerable difference of opinion, as is always the case where a natural problem presents itself for solution outside the domain of what are termed the exact sciences. In all probability, an earthquake is one of the necessary consequences of the gradual cooling of the earth. As the terrestrial heat is gradually declining through its radiation out into space, it follows that the bulk of the earth must be gradually shrinking.

No doubt the diminution of the earth's diameter from this cause must be small, even in a long period of time. But the shrinking is nevertheless continually in operation, and accordingly the crust of the earth has from time to time to accommodate itself to the fact that the whole globe is slowly but surely getting smaller. It follows from these considerations that the rocks forming the earth's crust over the surface of continents, islands, and under the beds of the ocean, must have a declining acreage year after year. So that of necessity the rocks must compress either continuously or occasionally; and their yielding will usually take place in regions where the earth's crust happens to have least power of resistance.

The acts of compression may be and usually are irregular, with small successive shifts; and though the displacement of the rocks in these shifts may be actually small, yet the pressures which the rocks are subjected to are so great that a very small shift may correspond with a very great terrestrial disturbance.

Suppose that there is a slight shift in the rocks in each side of a crack or fissure at, say, a depth of ten miles, where the pressure would be about thirty-five tons to the square inch. Even a slight displacement of one extensive surface over another, the sides being pressed together with a force of thirty-five tons to the square inch, would be an operation accompanied by violence greatly exceeding that which we might expect from so small a displacement, if the forces concerned had been only of more ordinary magnitude. It can be readily understood that these violent movements under the surface of the earth must cause great changes and commotion over-ground, resulting in the wholesale destruction of houses, villages, and even large cities, and in frequently great sacrifice of human life.

When an earthquake occurs under the floor of the sea, at a great distance from land, it does little harm; but when it happens near the shore, as it did a few days ago, on the coast of Southern Italy, it causes great damage and loss of life. When the disturbance occurs under the bed of the sea, the waters above it become uplifted, and the shock spreads outwardly. As the waves approach the shore, the friction or drag on the sea bottom decreases their speed, but greatly increases their height. On a low-lying coast such waves (usually misnamed "tidal waves") are generally

very destructive, which is unfortunately verified in the Italian disasters. Both earthquakes and volcanoes are more frequently found near the sea coast than inland. In the United States, earthquakes are most common in California. There appears to be a seismic zone encircling the world in which earthquakes are more numerous than elsewhere. It includes Central America, West Indies, Azores, Italy, Persia, Afghanistan, Tibet, Japan, and Hawaii. Earthquakes are common in volcanic regions.

Volcanoes are caused in the main by the same conditions and influences that give rise to earthquakes. But they are different in their manifestation. Volcanic eruptions are caused by leakage or percolation of water through cracks or crevices of the earth or rocks in varying quantities—sometimes in large quantities. As it comes in contact with the great heat in the lower parts of the earth's crust, the water is converted into steam. The steam finds violent vent in an explosion that removes the pressure from the lava, which in turn is forced up through the vent.

This internal heat causes evolution of a great body of elastic vapor, which, expanding and seeking an outlet where there is least resistance, shows itself in upheavals and explosive eruptions. The body of vapor supposed to be derived from superficial masses of earth becomes hydrated, or combined with water. Such action, as well as the presence of molten rock known as lava, is accounted for by vast internal displacements, bringing the inner crust with its high temperature nearer the surface. A great portion of the material thus upheaved is lava.

Lava is largely composed of silica and silicates; those containing a relatively small percentage of silica being called basic, and those containing considerable silica, acid. The acid variety of lava is lighter. Sometimes it does not move from the lava vent, and when it does it generally proceeds a short distance only, solidifying into a thick mass. The basic is much more liquid, and covers the slopes of the mountains or forms a lake on the adjacent plains. At the surface the lava is torn apart by the steam, the fragments being hurled high in the air. The fragments are known as cinders, and when finer as ashes. There are also numerous accessory phenomena, such as earthquakes, electric and magnetic disturbances, and acoustic manifestations, accompanying a volcanic eruption.

Both earthquakes and volcanoes have been inseparably bound up with the evolution of our planet for countless ages past, but their duration must have its limit, although that limit may be tens and even hundreds of thousands of years hence.

The present inert and dead condition of our satellite—the moon—once the center of great volcanic activity, points unmistakably to the fate that sooner or later awaits this earth of ours.

**British and German 1909 Warships.**

BY PERCIVAL A. HISLAM.

Great secrecy is being maintained concerning the details of the two armored ships to be laid down for the British navy in the current year. The following particulars have, however, been furnished by a reliable authority. The battleship, to be called the "Neptune," will be laid down at Portsmouth, and will follow the same general lines as the "Dreadnought." She will be 510 feet long, with a beam of 82 feet, and her normal displacement will be 20,250 tons. Her main armament will be the same as that of the "Dreadnought"—ten 12-inch guns—but she will probably have 4.7-inch weapons in the anti-torpedo battery. The disposition of the heavy guns will be the same as in the pioneer ship of the class; that is to say, three turrets will be on the center line, one forward and two aft, and one on either beam. The second center-line turret counting from aft will, however, be raised so as to fire over the aftermost, as in the "Michigan" and "South Carolina," thus giving the ship an advantage of two guns over the "Dreadnought" in astern fire. The designed speed of the ship will be 21 knots with turbines of 24,000 horse-power. Plans for a vastly improved battleship are in the possession of the British Admiralty, but will not be used until the ships of the 1909-10 estimates are commenced. The "Neptune" will complete a squadron of eight battleships of the same speed, armament, and general design. She will be completed for sea in the spring of 1911.

The other armored vessel of the 1908-9 programme is a cruiser, named the "Indefatigable," which is to be built at Devonport. This ship will be a greater improvement on the "Indomitable" class than the "Neptune" will be over the "Dreadnought," although the superiority will be largely a nominal one. The "Indefatigable" will be about 570 feet long with a beam of 80 feet, and will displace normally 18,000 tons—700 tons less than the latest German armored cruiser. It will be remembered that all three ships of the "Indomitable" class, although designed for only 25 knots, greatly exceeded this on their trials. The new vessel has been designed for a speed of 28 knots, and if she exceeds the designed figure as much as the "Indom-

itable" did, she will exceed 30 knots—which is greater than the speed of most of our destroyers. Her horse-power, with Parsons turbines, will be 45,000, or 4,000 more than the horse-power of the "Indomitable." Like the "Neptune," she is to be completed early in 1911, by which time Great Britain will possess eight "Dreadnought" battleships of 21 knots and four all-big-gun cruisers of 28 knots.

The "Indefatigable" will carry the same armament as her predecessors, namely, eight 12-inch guns. In the "Indomitables," however, it has been found very difficult to obtain a broadside of all eight guns, as was sought in the designs, and in the new ship the disposition of the armament will be so altered as to make this operation quite simple.

The German naval estimates for 1909, recently published, plainly indicate the energy with which that nation is pushing forward her naval development. During the coming year Germany will complete her first "Dreadnoughts"—the battleships "Nassau" and "Westfalen," each of 17,760 tons and armed with twelve 11-inch and twelve 6.7-inch guns. In addition, the armored cruiser "Blücher," of 14,600 tons and carrying twelve 8.2-inch and eight 5.8-inch guns, will be completed. The two battleships will join the high sea (or active battle) fleet, but the "Blücher" is destined to relieve the "Fürst Bismarck" on the China station. The 1909 estimates also include the last installments but one for the battleships "Rheinland" and "Posen," each of 17,960 tons and carrying the same armament as the "Nassau" and "Westfalen"; and also for the armored cruiser "F," not yet launched, of 18,700 tons and armed with twelve 11-inch and a number of smaller guns. The speed of all these battleships will be 19 knots, while that of the "Blücher" will be 23, and of the "F" 25 knots, the latter to be obtained with turbine engines of 45,000 horse-power, or 4,000 more than the designed horse-power of the British cruisers of the "Indomitable" class. Two small cruisers—the "Kolberg" and "Ersatz Jagd"—will be completed during the year, as well as a gunboat for river service in China and a division of twelve torpedo-boat destroyers. The cruisers are of 3,740 tons and 25.5 knots, having turbines of 18,000 horse-power, their armament consisting of ten 4.2-inch and a number of smaller guns. The destroyers are of 660 tons and 30 knots.

The other vessels upon which work is to be continued during 1909, and which will not be completed before 1911, are the three battleships to replace the "Beowulf," "Siegfried," and "Oldenburg," the armored cruiser "G," two small cruisers to replace the "Schwalbe" and "Sperber," a division of destroyers (twelve), and a number of submarines. Authentic details of these ships are lacking. During the year a commencement will be made with work on three new battleships, to replace the "Frithjof," "Hildebrand," and "Heimdall," the armored cruiser "H," two small cruisers to replace the "Bussard" and "Falke," twelve torpedo-boat destroyers, a tender for the torpedo experimental division, and several submarines, the latter to cost \$2,500,000. Several of the large vessels in the fleet are to be taken in hand for thorough repair, and two floating docks are to be built, one with a lifting capacity of 40,000 tons for the imperial dockyard at Kiel, and one of 1,000 tons (for torpedo craft) for the imperial yard at Danzig.

The programme of warship construction may be summarized as follows:

	To be completed.	To be continued.	To be commenced.
Battleships .....	2	5	3
Armored cruisers .....	1	2	1
Small cruisers .....	2	2	2
Destroyers .....	12	12	12

**The Current Supplement.**

Mr. F. P. Veitch's article on paper-making materials is concluded in current SUPPLEMENT, No. 1725. Mr. W. A. Tookey writes on oil engines. W. Carlile Wallace contributes an article on some recent inventions as applied to steamships. When a man of science is asked what caused the earthquake at Messina, he must confess his ignorance. Dr. F. A. Jaggard shows how very little we know about earthquakes, and outlines the proper method of studying seismic disturbances. "Liebig as a Teacher" is the title of an article which gives an admirable picture of a great chemist's personality. Prof. R. A. Fessenden's paper, giving a brief history of wireless telegraphy, is concluded. The nature and cause of seasickness are explained. Prof. Otto N. Witt, the well-known German chemist, writes instructively on waste and conservation of natural resources; and the issue also contains articles on the first Paris Aeronautic Salon and on the general characteristics and details of construction of French flying machines.

Weather-resistant Plaster Mortar.—Mix 6 parts of freshly-burned plaster, 3 parts of brick dust, and 4 parts of blast-furnace slag sand with sufficient water, into a mortar and immediately before use add 2 parts of iron filings.

**Correspondence.**

**ORIGIN OF THE WORD "SCIENTIFIC."**

To the Editor of the SCIENTIFIC AMERICAN:

The leading dictionary reports as not found the word "scientificus," from which our word "scientific" is derived. Your issue of January 26, 1907, reported the Latin "scientificus" as found in Robert of Lincoln, in or about 1246. Progress may now be reported. In translating Aristotle, Boethius, in the early part of the sixth century, repeatedly uses the word "scientificus," to render Aristotle's "epistemonicos" (see Boethius, vol. 64 of Migne's Latin Patrology, 720 A, 973 C, 993 D, 1039 C). It is well known that these works of Boethius were forgotten until the revival of the thirteenth century, in which Albertus Magnus was the leader. Since then, the interesting word has been the common possession of mankind. It was started in Greek by Aristotle, it was given its Latin form by Boethius, it was introduced into the literature of science by Albertus Magnus. C. W. ERNST, Boston, Mass.

**AEROPLANES IN WARFARE.**

To the Editor of the SCIENTIFIC AMERICAN:

In a recent issue of your magazine you represent on your front page a Wright flyer with two men in it making a map of the country of an enemy. In the magazine you state that in all probability the only use for this type of machine will be for scouting, as you consider that the modern open-order formation for infantry will prevent much damage being done by bombs dropped from above. Have you not, however, overlooked the vulnerability of headquarters? Flyers would not trouble infantry, but would make for the opposing headquarters, and how could these be protected in a way that would still allow the staff to see and know what was going on? With Wright flyers common, I can not see how any staff could direct an army and keep itself out of the danger zone. With the safety of the general staff gone, what would become of the morale of an army?

In defending a city against an approaching fleet, the possible damage flyers could do is very great. Several hundred of them, each equipped with a bomb of dynamite, could be sent out from a base, each returning, after dropping its bomb, to reload, and this line of flyers could sail out and back for hours, returning simply for bombs and gasoline. These machines could attack a fleet twenty miles out, and what chance would the fleet have of reaching the coast through this rain of dynamite? Flyers and men are cheap where it is a question of destroying battleships.

I am of the opinion that the Wright flyer offers the cheapest method of defense against an opposing force ever invented, and that the effect of its use will be to diminish the cost of self-protection and to decrease the chances of war by so increasing the size of the danger zone as to make war as dangerous to the commander as it is now to the private.

I would be pleased to have you publish this in your magazine, and would like the comments of others on this point. A. A. MERRILL, Boston, Mass., December 22, 1908.

**MULTI-HULL STEAMSHIPS.**

To the Editor of the SCIENTIFIC AMERICAN:

In your article in the SCIENTIFIC AMERICAN for January 9, you give an account of a projected three-hull type of fast ocean steamer, and in your discussion of the matter, you appear to have mixed up the swinging saloon steamer "Bessemer" and the catamaran steamer "Castalia."

As to the newness of the plan, I have in my possession the plans of a ship of the same type, which were patented by a Capt. Coppen, an old North Atlantic captain, who built and ran some of the very first steamships on ocean routes, and which plans he gave me over twenty years ago. You will find these plans discussed in London Engineering or Engineer for that time, also in Preble's "History of Steam Navigation."

The "Bessemer" was a single-hulled ship, of about 350 feet length and 60 feet beam; she had turtle decks at forward and after ends, 48 feet in length, with a freeboard of only 3 feet, while the rest of the hull was covered with a superstructure having a freeboard of 11 feet.

This superstructure contained the swinging saloon, which was hung compass fashion, with the addition of hydraulic buffers, which took up or controlled the motion. The saloon was 70 feet long, 35 feet wide, and 20 feet high. In the two ends of the midship house were located the engines and boilers.

There were two paddlewheels on each side, 106 feet center, 27 feet in diameter, with twelve feathering buckets each.

She was expected to run ferryboat fashion, without having to make a turn. The engines developed 4,600 horse-power, and were expected to drive her 18 to 20 knots. With her low freeboard she could not be driven, as the seas nearly pounded her to pieces.

The "Castalia" was a catamaran of two hulls; her length was 290 feet, beam 60 feet, with a well or space of 26 feet between the hulls, in which were two paddlewheels abreast on independent shafts, each wheel run by two separate sets of engines.

Great speed was expected, but she did no better than the vessels then used in crossing the Channel; in fact, she was not their equal, as the seas choked the wheels. She was laid up, finally sold, and on her deck were built a number of houses, and she became a floating hospital.

The "Castalia" was built in 1873, and the "Bessemer" in 1875.

The Engineer and Engineering for those dates have, I am told, articles thereon. See also Preble's "History of Steam Navigation," pages 247 to 249, 278, and 410.

In Capt. Coppen's plans, the central hull is considerably shorter than the wing hulls, and he has the propellers arranged at each end of this central hull, in the manner of our new-style ferryboat, as first placed in the Hoboken ferryboat "Bergen"—one to pull, the other to push. JAMES M. LINCOLN, New York, January 7, 1909.

### THE MEAT INDUSTRY OF AMERICA.—I.



AMERICA is the home of colossal industries. The American people have a genius for organization which has found expression in certain aggregations of men, machinery, and capital which are among the wonders of our twentieth century civilization. Conspicuous among these is the vast meat industry, which in the range of its operations, from the mul-

titudinous flocks on hillside and plain to the fresh meat or canned product as delivered to the individual householder, involves the employment of hundreds of thousands of men and the turning over of money that must be reckoned by the thousand millions.

The latest estimate of the value of meat animals on farms and ranges, made by the Department of Agriculture, January 1, 1907, is \$2,152,320,349. In 1905 the value of live-stock farms and ranges was estimated to be nearly eight billion dollars, and the capital directly related to meat production for export alone is \$10,625,000,000, or five-sixths as large as all capital invested in manufacturing in 1904. It is estimated that the farm value of the available slaughter of 1907 will be worth at the farm at least \$730,000,000.

In the development of the great industries of the United States to which we have referred above, there is a tendency to concentration at certain cities which, by virtue of their geographical location or other strategic advantages, are particularly well placed to serve as the centers of activity. Conspicuous among these is Chicago, which holds the same relation to the meat industry that Pittsburg does to steel. Sixty-four per cent of the population of the United States is east

of Chicago; while seventy per cent of the farm animals lie to the west of that city. The great east and west transportation lines have their terminals there, as have also the southern railways and the lake transportation lines. The pre-eminence of Chicago in the meat industry is shown by the fact that since 1900 there has been marketed and sold in Chicago a yearly average of over 16,000,000 animals, valued at over three hundred million dollars, and that this number is about half the total combined receipts of the six principal live stock markets of the United States.

The meat industry of Chicago, from the purchase of the live stock to the shipment of the meat, in either the fresh or the cured condition, is carried on at the Union Stock Yards, which are located near the out-

town. The whole of this area, a half mile in width, and a mile in length, is paved with red brick; and here we see the first notable evidence of the effort to maintain the stock yards in a sanitary condition. The brick paving makes it possible to thoroughly clean both pens and streets, and this is done at regular and frequent intervals. At the time of our visit, although there had been several days of drizzling rain, the yards presented conditions of cleanliness superior to those which can be found in the farmyard of the average American farm, and comparable to those of a well-appointed livery stable.

Whatever may have been the conditions in the past, it is a fact that to-day the greatest care is exercised in the shipment and handling of the stock from the time it leaves the farm until it enters the packing houses. The price that the animals will fetch in the pens depends upon the condition they present under the eye of the buyer who represents the packing houses; and it is to the interest of the farmers, the cattle-men, and the commission men to whom the cattle are consigned at the yards, that they shall receive the best food and the most careful attention up to the very hour at which the sale is made. They are shipped in special stock cars, in which they are carried as expeditiously as possible to the stock yards, where they are unloaded and driven to the pens. Here they are at once fed and watered, each pen containing a feeding trough and a water trough into which a stream of fresh water is kept running. The cattlemen consign their

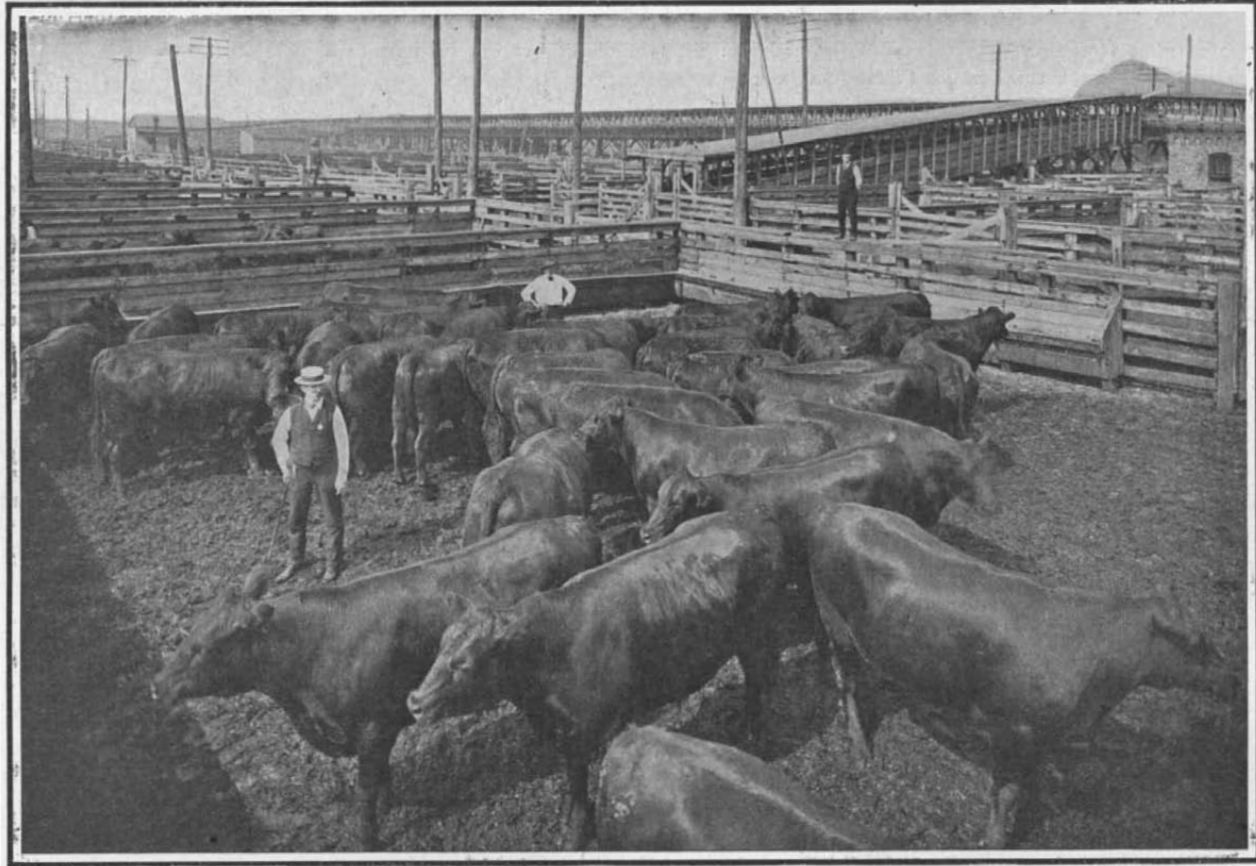

The stockyard pens, where the cattle are purchased for the packing houses. One of the United States inspectors who examine the cattle on the hoof is seen in the foreground.

skirts of the city. The yards cover exactly a square mile of ground. One-half of this area is covered with cattle pens, and the other half by the huge establishments of the packing houses. The pens are surrounded by stout stockades about shoulder-high, and they are laid out in blocks with streets and alleys, in much the same fashion as an ordinary American

stock to the various commission houses, and for receiving and selling the stock there is a charge of respectively twenty-five cents and fifty cents a head. The purchase of the cattle is made by buyers, of whom each of the packing houses maintains a regular staff. To enable the writer of the present article to judge of the condition of the yards and determine for himself how far the

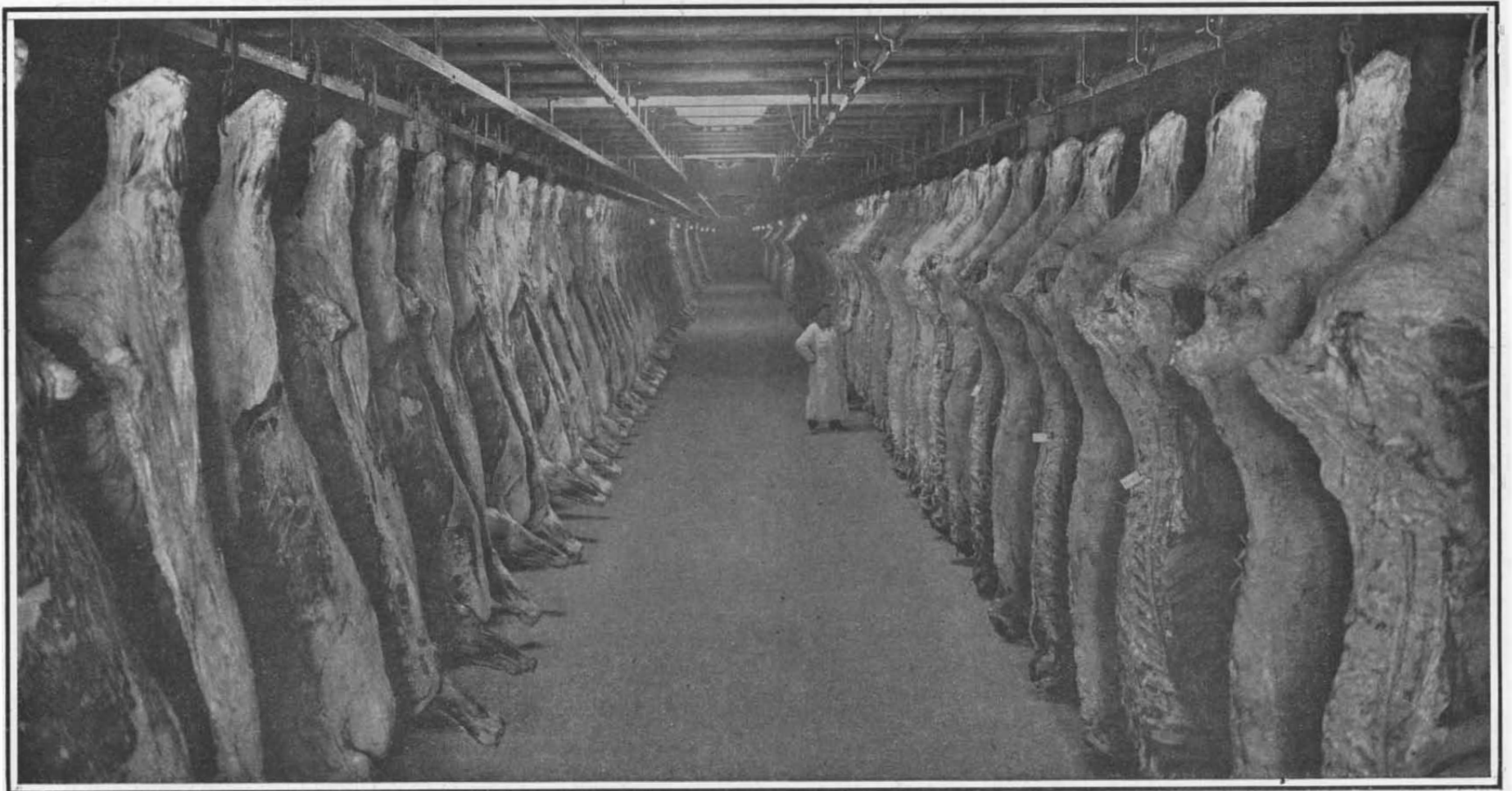

The beef, dressed ready for shipment, is hung for two days in this room, which is maintained at a temperature of 32 deg. F.

The chill room. Capacity, 3,000 sides of beef.

THE MEAT INDUSTRY OF AMERICA.



conditions of buying and selling warranted the oft-repeated statement of the newspapers that the market is controlled in the interests of the packing houses, he secured a horse and took an opportunity to ride into the pens and listen to the bidding as carried on between the buyers and the commission men. It must be confessed that the observations of that two hours

stock raisers. As regards the buyer, it may be said that the margin of profit is so small, being about two per cent in the case of Swift & Co., whose buyer the present writer accompanied during the morning's work, that the prosperity of the house may be said to depend more upon his judgment of the condition of the cattle, and skill in securing the lowest prices,

later," says the buyer, and drives out of the pen, explaining to the writer that in his judgment the market will be lower as the day wears on. We next entered a pen containing what the buyer defined as prime, corn-fed cattle. Question: "What are you asking?" Answer: "Seven seventy." "Make it seven fifty." The commission man refuses to come below

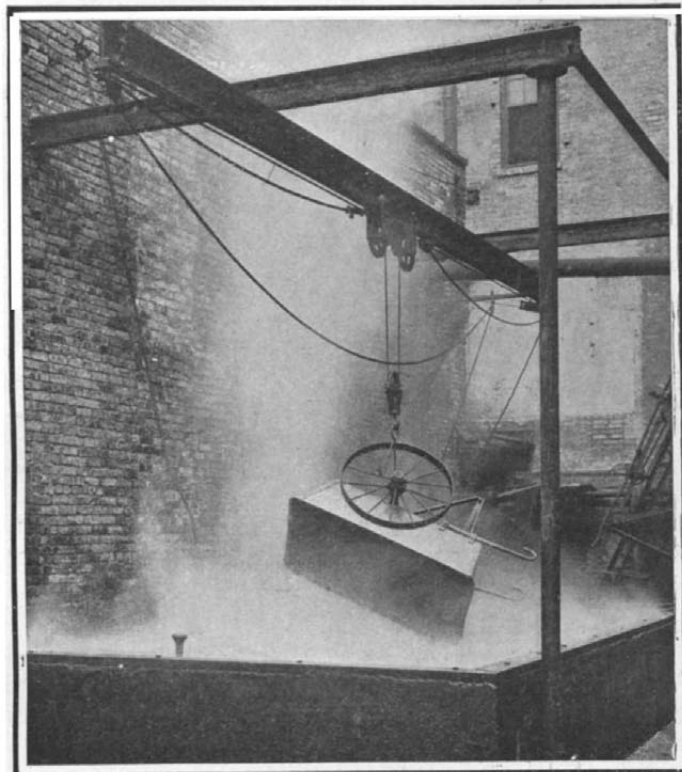

The trucks in which the meat is handled are periodically sterilized by plunging them bodily into a vat of boiling water.

**Sterilizing a box truck.**

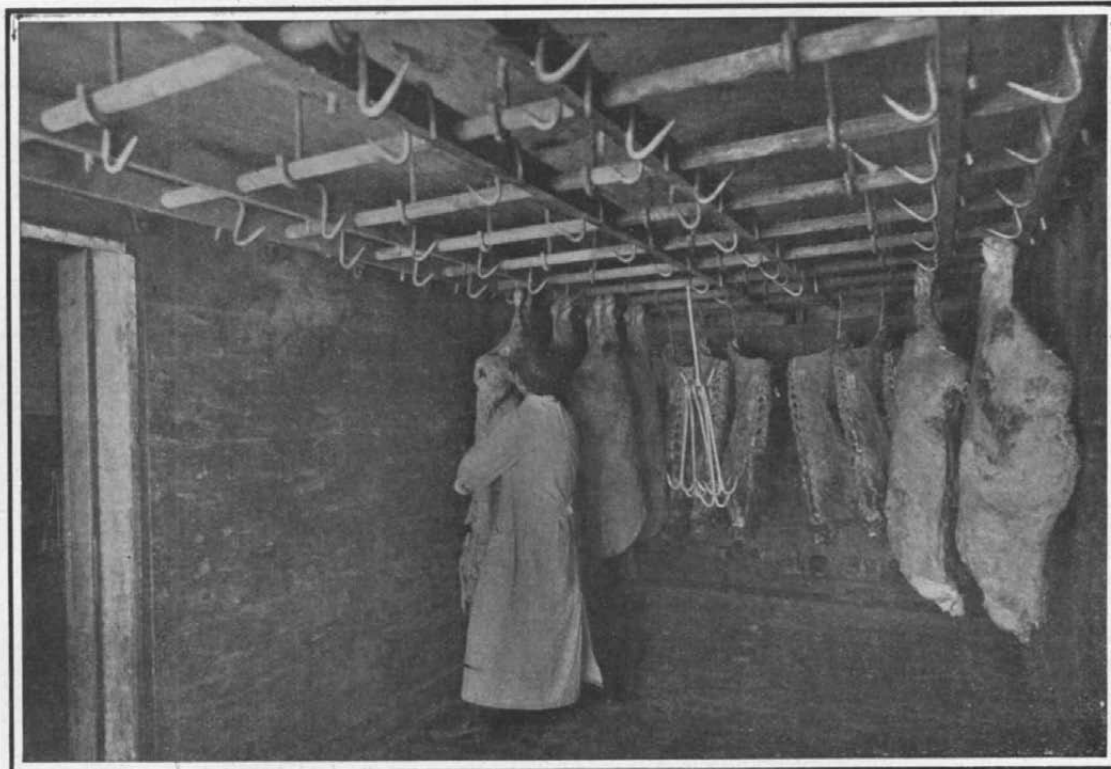

This interior view of a refrigerator car shows how the beef, during its journey to the branch distributing house, is hung in a refrigerated atmosphere similar to that in the chill room.

**Loading the beef into the refrigerator car.**

spent in the pens left the impression that the competition was keen, the commission men trying to get the best possible price for the farmer and the buyers the lowest possible figure for their respective houses. This conviction is deepened by the fact that the supply of cattle seems to be less than the demand for the trade, and always less than the capacity of the packing houses; that there is a natural rivalry between the houses themselves to show the largest output; and that, since the profit of the commission men is at a fixed rate of fifty cents per head, there is a natural desire on their part to sell all that they can at the highest possible figure; for the commission men who secure the reputation for obtaining high prices will naturally command the confidence and trade of the

than upon the efforts of any single individual concerned in the business. It is claimed by the Stock Exchange Protective Association, which was formed to safeguard the interests of those who ship their stock to the yards, that the scale of trading morality is exceedingly high, and that an instance of "shady work" on the part either of commission men or buyers is practically unknown. The buyer, accompanied by the commission man, rides into a pen of cattle; looks them over with a rapid glance of his thoroughly practised eye, and quickly decides whether he will buy at the price demanded. In one particular case, of which note was made, the following laconic conversation occurred: The buyer: "Six fifty." The commission man: "Make it seventy-five." "See you

his first figure; but as we ride out of the pen, calls out "Sixty," and the buyer immediately answers "Weigh 'em," explaining that this signifies that the deal is consummated and the cattle are to be driven to the scales preparatory to going to the house of Swift & Co. for killing. We had the curiosity to ask the buyer what was the sum of money involved in a transaction that took less than thirty seconds to complete, and found that it amounted to over \$7,000.

Before following the stock to the packing house, it will be well to make some general observations upon the scope and purpose of the vast buildings which occupy that other half square mile of ground adjacent to the pens. The complicated organization represented by these establishments has for its object the dressing

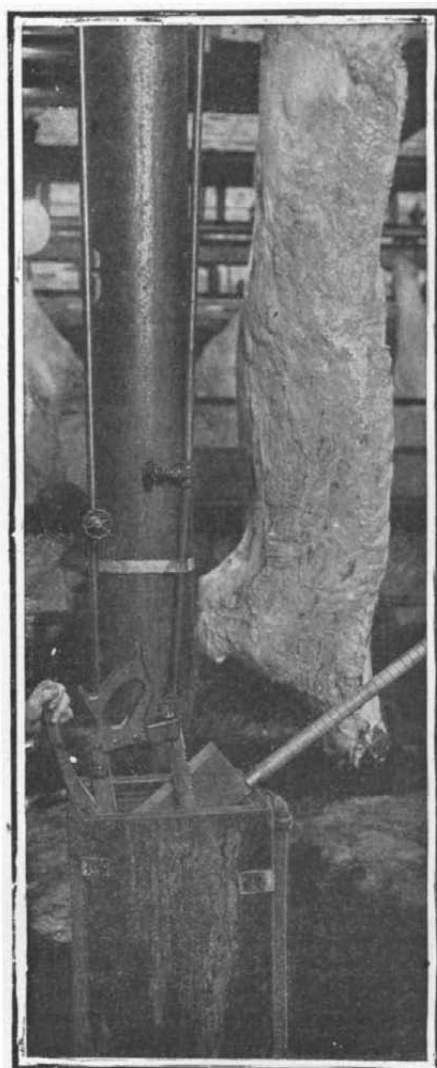

Tank containing bichloride of mercury solution in which dressing tools are disinfected.

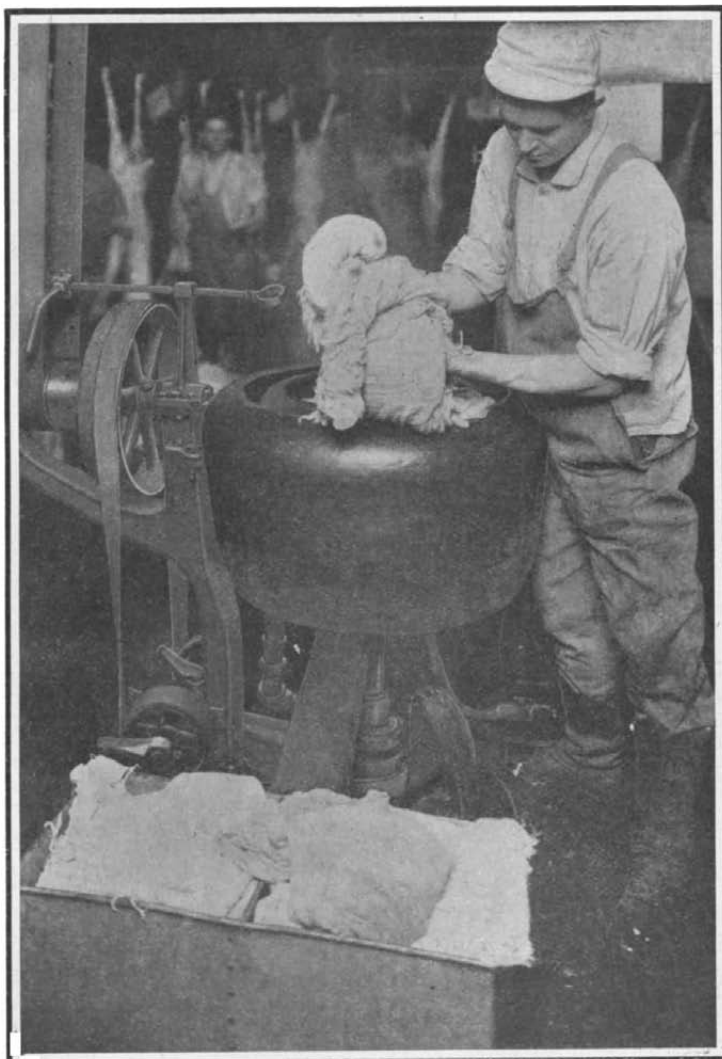

Centrifugal drier for washing cloths used in the dressing of the beef.

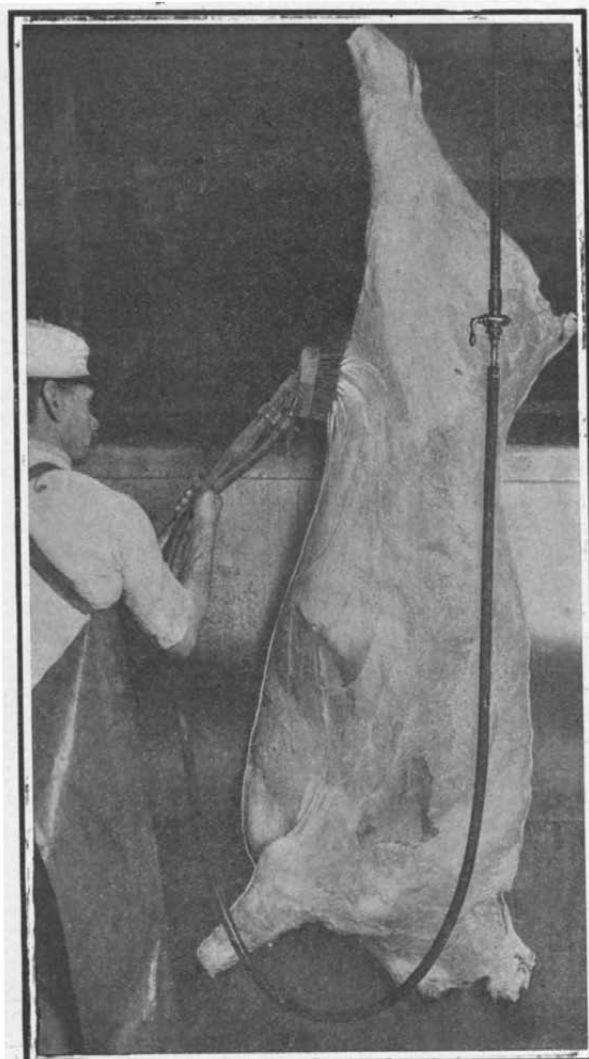

Washing down the sides of beef with a brush through which flows a stream of fresh water.

and preparation of the meat, either by refrigeration or curing, in such a way that it will stand a journey to any part of the world and reach the retail dealer in a perfectly clean, wholesome, and palatable condition.

Broadly speaking, there are three methods of preservation, namely, refrigeration, curing, and canning. The present article will deal with the methods of refrigeration and curing as carried on at the establishment of Swift & Co., through whose courtesy we obtained ample opportunities to examine every detail of their plant during a recent visit to the stock yards. The art of meat preservation may be described as a process for the arresting of that law of nature by which all animal tissue, as soon as life is extinct, tends to become resolved by a process of deterioration into its chemical constituents. This can be done either by lowering the temperature of the meat to a point below that at which the bacteria are active, or by treating it with certain salts and substances which secure the same effect. It will be evident at once that the very first requisite in work of this character is that the animals must be absolutely healthy and in first-class condition.

One of the strongest impressions produced upon a visitor to the packing houses is that every possible precaution is being taken to insure the entrance only of healthy animals into the dressing room, and provide for the detection and removal of any that excite the slightest suspicion. This part of the work is in the hands of the United States government, and is under the immediate supervision of the United States Department of Agriculture. The inspection is divided into two kinds—the *ante mortem*, which takes place when the cattle are unloaded into the stock pens, where any animal which by its appearance or actions indicates that it is not in perfect condition is rejected or held for further examination; and the *post mortem*, which takes place after the killing, and consists in a careful examination of the various organs. The *post mortem* examination is made at various points during the process of cutting up, and is continued on the dressed and cured meats up to the very hour of shipment. The personnel of the inspection corps is made up of men who must have successfully completed a three years' course in veterinary medicine at a reputable veterinary college. The Civil Service Commission examines these graduates and about 50 per cent of those examined make the desired grade of 70. The salaries are generous and the promotion of men to higher positions is dependent upon ability. The force is divided into the head inspectors; the laboratory inspectors, who have to pass a civil service examination in bacteriology and chemistry; the inspector's assistants, who examine live stock, stamp the meat, seal the cars, and superintend the removal of condemned meat; and the meat inspectors, who are experts in pickling, salting, smoking, and otherwise curing the meat. We made it a point to converse with several of these men and found them to be intelligent and zealously interested in their work. They stated that the packing-house management was disposed to give hearty co-operation, realizing that the more satisfied the public was of the thoroughness and unbiased character of the work, the better it would be for the houses concerned.

The cattle, after inspection and purchase in the pens, are driven along runways to the dressing floor. The animal is stunned by a blow with a large hammer and hoisted by means of a shackle attached to the hind legs onto the rail of an overhead tramway. While in an insensible condition it is dispatched by severing the principal arteries in the neck. It is then carried forward on the rail; and the operations of dressing follow in quick succession. First the lower joints of the legs are removed, and then the "sider" skins the animal as far down as he can without exposing the parts to contact with the floor. The animal is next opened and the viscera are removed. By means of saw and cleaver the beef is then split entirely in two through the vertebrae. The rough pieces of meat, the spinal cord and other portions are then removed by the trimmers. Next the separated parts are moved down the rail in front of long benches, where other workmen give them a thorough washing with hot water, using a stiff brush from the center of which a hose throws a stream of water against the meat, which is subsequently wiped thoroughly dry with clean cloths. By this time the beef is ready to be passed on to the chill room.

During these various processes the meat has been subjected to careful scrutiny on the part of a United States inspector. When the head is severed an inspector examines the glands which are the common seat of tubercular trouble. At the removal of the viscera another inspector is on the lookout for any indication of abnormality. If there is any evidence of disease, the inspector attaches to the animal a tag on which are the words "U. S. Retained." This tag is numbered to correspond with the number on the stub, which latter he forwards to the office of the inspector with his report. The suspected animal, with

any parts which may have been already separated from it, is placed in an iron truck, wheeled away under the eye of the inspector, and locked up in what is known as the "retaining room," the keys of which never pass out of the hands of the government officials. In this room the animal undergoes a final and more

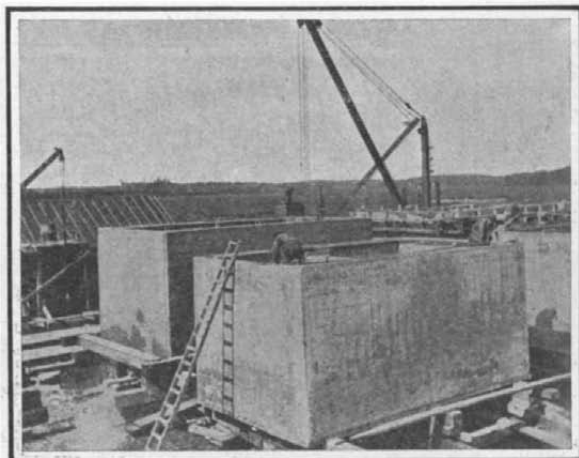

Fig. 1.—Building the caisson.

thorough inspection, and upon condemnation it is removed and completely destroyed.

Returning now to the sides of beef which have been dressed, washed, and wiped, and have passed the inspection above referred to, the government inspector marks each with a metal or rubber stamp which reads "U. S. Inspected and Passed," and the sides are then

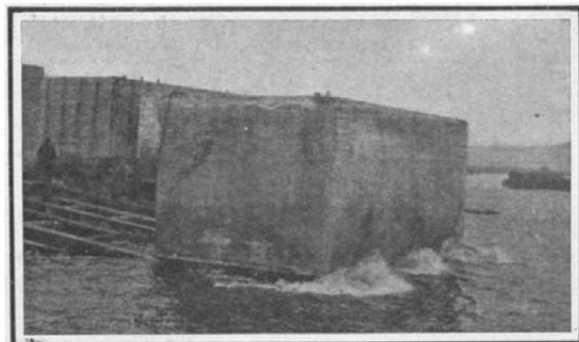

Fig. 2.—Launching the caisson.

wheeled along the overhead rail into a vast apartment known as the chill room, where they are held at a temperature of about 36 deg. F. for forty-eight hours. In the chill room, at the time of our visit, some three thousand sides of beef were hanging. Here, during the time the beef is maintained at the temperature stated, it is subjected to a continual circulation of cold air

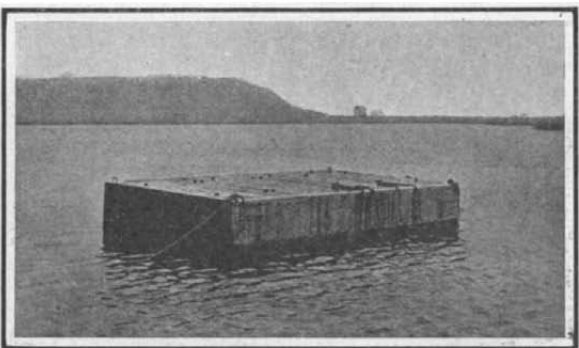

Fig. 3.—Ready to be towed into position.

by a process known as the moist refrigeration method, which is designed not only to reduce the temperature of the air, but also to rid it of bacteria, dust, and other impurities. The cooling and cleansing of the air is done in a large chamber immediately above the refrigerating room. Here are suspended, in long rows extending entirely across the chamber, thousands of

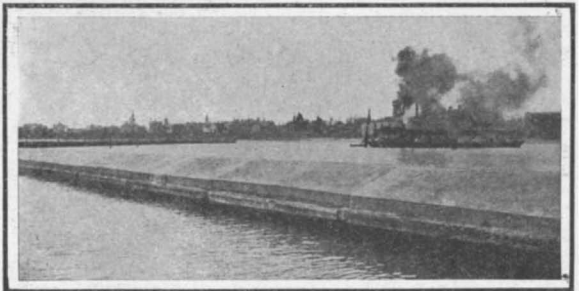

Fig. 4.—Section of completed breakwater.

#### CONCRETE STEEL CAISSONS.

large sheets of burlap, over each of which trickles continuously a stream of cold brine. The air, drawn in from the outside, is caused to pass between the burlap, where any dust and bacteria which may be in the outer atmosphere are deposited, and the temperature is lowered to the desired point. After pass-

ing the burlap, the pure air falls by its own gravity through openings in the floor, arranged directly above the sides of beef in the room below. From the refrigerating room the beef that is to be shipped is wheeled out on overhead rails into the refrigerator cars, where it is hung in symmetrical rows on hooks suspended from the ceiling. At each end of the car is a narrow compartment walled off by boarding which extends from floor to ceiling, but is provided with openings at top and bottom for the circulation of the air; and in these compartments are placed tanks loaded with ice and salt. The air passes in through the vents at the top; is cooled; and falls by gravity to the bottom, whence it issues into the body of the car, a constant circulation of cold air being thus secured.

There are in various parts of the country over three hundred local Swift & Co. distributing houses, where on the arrival of cars the meat is wheeled out on overhead rails into refrigerator rooms, from which it is purchased by the various retail dealers.

#### CONCRETE STEEL CAISSONS.

A new type of breakwater is being built at Algoma, Wis., of reinforced concrete caissons. These caissons are huge hollow blocks of reinforced concrete, each weighing 120 tons in air. They are 24 feet in length, 15 feet in width, and 12 feet 4 inches in height. They are built over launching ways and are launched like a vessel. After launching they are towed a distance of twelve miles to the harbor, where they are used in the construction of a breakwater.

In the breakwater they rest on a foundation of piles which are cut off 11 feet 4 inches under water. When the foundation has been prepared, the caissons are brought into the proper position and sunk by the admission of water into the hollow compartments. After the caissons have come to a firm bearing, the water is displaced by riprap stone, and this is sealed over with four feet of solid concrete. A superstructure with its crown three feet above the caissons completes the breakwater, which is protected on both sides by riprap.

Fig. 1 shows several caissons on the stocks; Fig. 2 shows one of these large blocks being launched. One of the caissons is shown afloat in Fig. 3, and Fig. 4 shows the finished breakwater.

These caissons were invented by Major W. V. Judson, who holds a patent covering the invention, and under whose supervision the above breakwater was designed and built.

#### Disposal of the Heany Patent Fraud Case.

The Heany patent fraud case, which involved a Patent Office examiner, N. W. Barton; a patent attorney, Henry E. Everding; and the inventor, John Allen Heany, himself, has been decided at Washington. Barton withdrew his plea of not guilty, and pleaded guilty. Everding practically admitted guilt to some of the charges, but denied guilt of any wrongful act in connection with one of the applications. Heany offered no evidence whatever. A verdict of guilty was brought in against Barton and Everding. Heany, the inventor, was acquitted.

The case in question involves the tungsten lamp patents, and the ultimate outcome will be watched with much interest.

#### Official Meteorological Summary, New York, N. Y., December, 1908.

Atmospheric pressure: Highest, 30.53; lowest, 29.38; mean, 30.06. Temperature: Highest, 64; date, 12th; lowest, 20; date, 10th; mean of warmest day, 52; date, 1st; coolest day, 26; date, 10th; mean of maximum for the month, 40.9; mean of minimum, 29.5; absolute mean, 35.2; normal, 34.1; excess compared with mean of 38 years, 1.1. Warmest mean temperature of December, 42, in 1891. Coldest mean, 25, in 1876. Absolute maximum and minimum for this month for 38 years, 68 and -6. Precipitation: 3.21; greatest in 24 hours, 1.91; date, 6th and 7th; average of this month for 38 years, 3.38. Deficiency, 0.17. Greatest December precipitation, 6.66, in 1884; least, 0.95, in 1877. Wind: Prevailing direction, west; total movement, 10,712 miles; average hourly velocity, 14.4 miles; maximum velocity, 50 miles per hour. Weather: Clear days, 7; partly cloudy, 9; cloudy, 15; on which 0.01 inch or more of precipitation occurred, 10. Snowfall, 5.1; sleet, 4th; fog (dense), 12th, 18th, 31st.

A new system of road-making, which, it is claimed, will stand the wear and tear of heavy traffic, such as motor wagons, and be virtually dustless, is to be tried on a more extended scale by the Lancashire County Council. It has already been tested on short lengths of road, and after four years' hard use the road shows no sign of wear. It is made with small granite sets  $3\frac{1}{2}$  inches to  $3\frac{3}{4}$  inches, laid in intersecting circles. This method of paving is said to be much more economical than paving with ordinary granite. At the instance of the County Council the system is to be tried on a length of main road between Accrington and Haslingden.

**CURIOUS LIFE HISTORIES.**

**THE STRANGE DEVELOPMENTS OF SOME INSECTS AND ANIMALS.**

Few things in natural history are more curious and interesting than the strange metamorphoses through which some lower forms of life pass before attaining

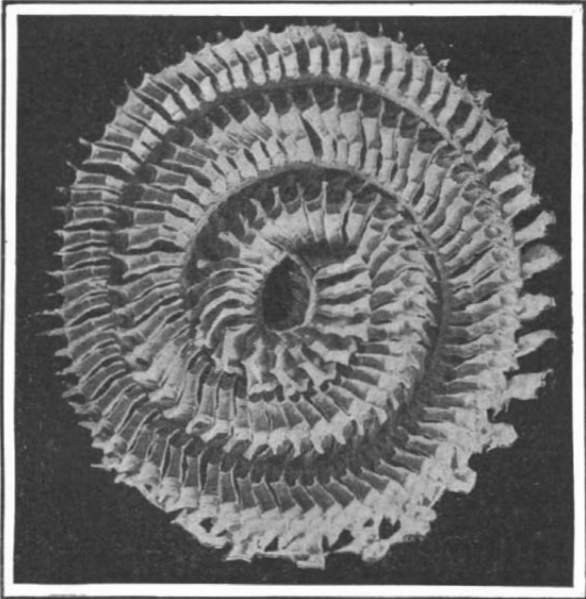

The numerous egg sacs of the conch, a large shellfish.

their final stage of growth. As is often the case in other lines of development, it is the least visible which is the most important part. The clothes moth, which is so often credited with fretting our woollens, does all its destructive work when it is a grub. So little has food to do with its final state, that the moth has not even a mouth. The heavy flying cicadas or locusts, which periodically appear in some sections of the country, have brief lives as flying insects; they lay their eggs to insure the next generation, and then their work is done. But as larvæ they have been living, under the soil, for a number of years—with some species for seventeen years. And so these flying cicadas

that we see are really of an age to which some large animals, such as dogs or cows, seldom attain.

There is no uniform rule governing these changes. A butterfly spends its caterpillar existence crawling from leaf to leaf, and does not become a freely-roaming creature until it has emerged from the chrysalis. "Baby" oysters or lobsters are free-swimming creatures at an early age, but later in life one attaches itself to a spot from which it never moves, while the other, not quite so anchored, finds some convenient hole or crevice in a rock, and stays in its vicinity.

The various stages of growth tend to illustrate the evolution from a lower type. To repeat an oft-quoted example, a very young baby has such a strong grip that if it takes firm hold of a stick or a rope, it may be lifted without relaxing its hold; possibly a memory of the days when our ancestors were tree dwellers. An example of this development is seen in the frog, which hatches from an egg into a gill-breathing tadpole, and later, as it grows legs and absorbs its tail, develops lungs, and becomes an air-breathing creature. The platypus, a curious mammal of South Australia, actually lays eggs, from which its young are hatched; the hoazin, a large South American bird, when a nestling has a claw on each wing, which enables it to scramble about trees. At this stage it develops reptile-like traits. Many winged insects pass the earlier stages of their existence as water dwellers. The commonest instance of this (in some sections of the country) is the mosquito, the larvæ of which, known as "wrigglers," swarm in stagnant water. This water existence, by the way, has proved the mosquito's vulnerable point. By draining or by pouring oil on the surface of the water, their breeding haunts have been broken up in many quarters, and the insects exterminated.

The sea is as full of changing life as the land. The receding tide often leaves strange wreckage behind it. One common and distinctive object is the egg case of the conch. As it lies stranded on the beach, it is curled in the shape of the well-known shell from which it has come. Each of the several hundred egg sacs in the chain contains eggs, or, later, tiny conches in tiny shells. Were this egg chain never cast up, but always safely anchored below low-water level, naturalists might still be speculating as to the early days of the conch as they did until recently when discussing the

eel. There used to be a theory that eels were spontaneously evolved from mud; a type of theory which had many applications in the days before nature study became a science. The mud theory was long ago abandoned, but naturalists searched in vain for a long time before they found tiny eels. At certain seasons of the year some rivers swarm with eels making their way upstream, and it was thought that the young must be looked for in the ocean. This supposition is now

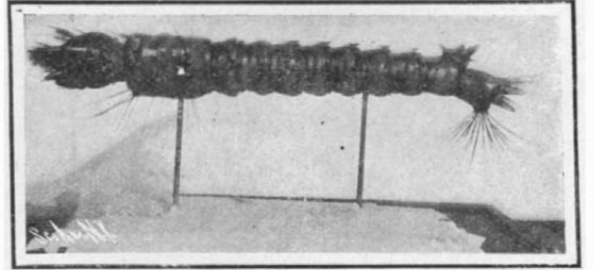

The larva of the common malarial mosquito.

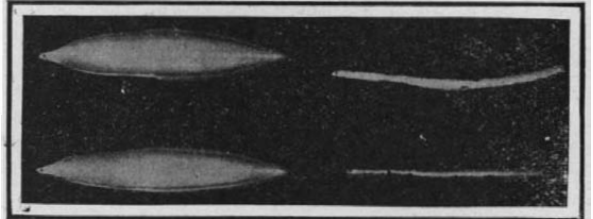

The young of eels are at first shaped like flatfish.

proved correct; but the baby eels when found resemble flatfish, and do not assume their snake-like shape until later.

The jellyfish of the ocean are also creatures with curious young. It is difficult sometimes for an inexperienced observer to decide whether they are plants or animals. There are jellyfish on which the young grow like fruit, and when "ripe" drop off to lead a separate existence; others trail a string of young on a long rope, and similarly shed them when able to fend for themselves.

To multiply instances of strange forms of young would be to go through the greater number of the lower forms of life.

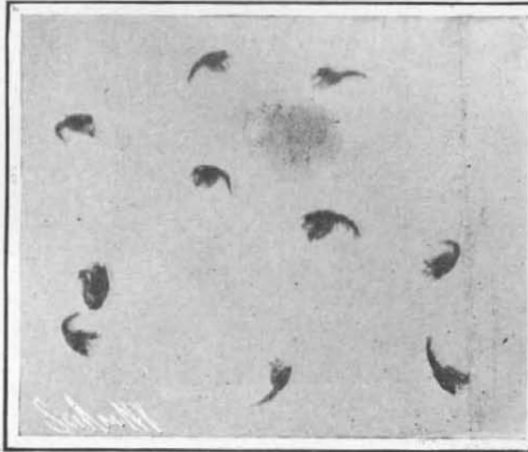

Free-swimming young lobsters eight days after their birth.

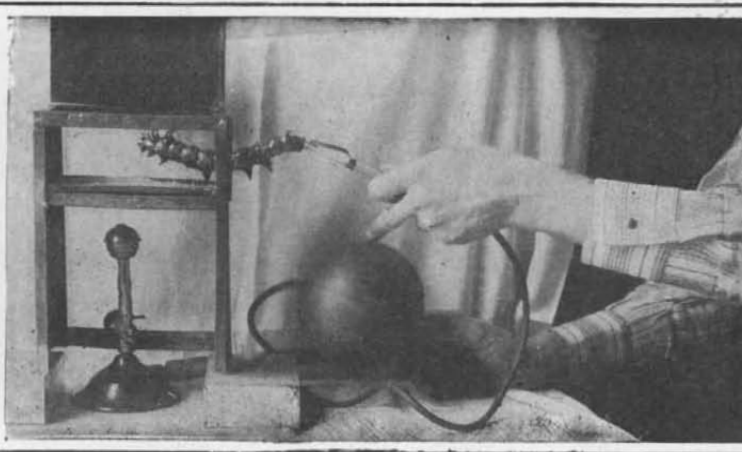

Preparing a specimen for a museum. The skin is first emptied, then inflated, and finally heated in an oven.

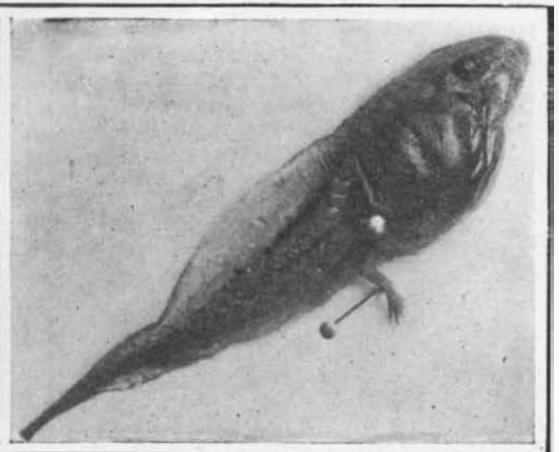

A tadpole just commencing to grow the hind legs.



The "hickory horned devil," the grub of a moth.

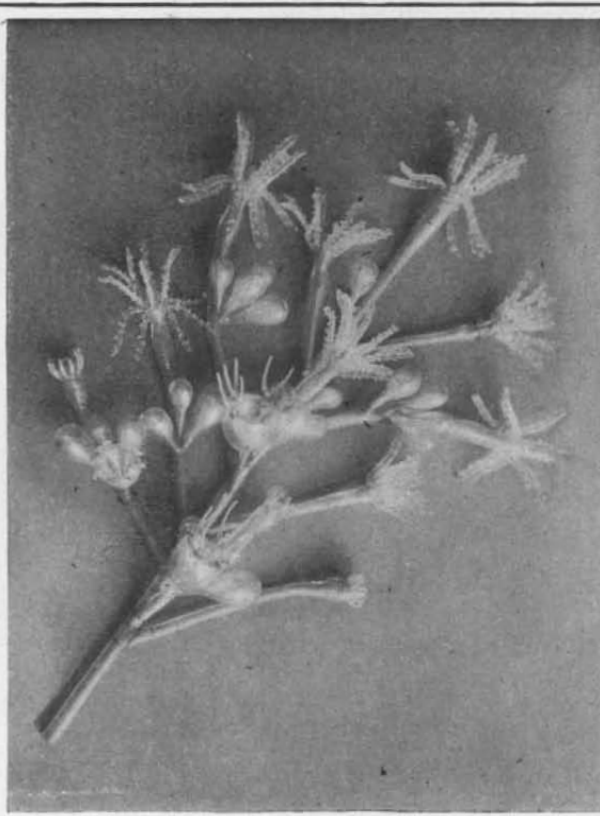

A jellyfish that bears its young like fruit and sheds them when ripe.



The young hoazins climb about trees after the manner of reptiles.



A marine animal with a long string of young



The Editor of Handy Man's Workshop will be glad to receive any hints for this department and pay for them if available.

### TWO WAYS OF IMPROVING A SLED.

BY J. A. BERGSTROM.

The accompanying illustrations show how an ordinary sled may be converted into a dirigible sled, and how it may be combined with a boy's hand car to make a motor sled.

#### THE DIRIGIBLE SLED.

Unlike the ordinary sled, that is steered by digging in the heels, or dragging the feet in the snow, from one side to the other, thereby checking the speed of the sled, the sled here shown has flexible runners, which may be curved to one side or the other by a steering bar, causing the runners to follow smoothly in the curving tracks. The sled should be built low and narrow, and the runners should extend well forward and rearward, which will materially add to the speed of the sled when coasting down a hill.

Fig. 1 shows an ordinary girl's sled, which is made into a flexible or dirigible sled. The top part of the runners, shown in dotted lines, is cut off on a level with the seat and the ends are fastened together with a transverse bar *a*, made of iron or wood. From this bar, and fastened thereto, are bars *b*, one on each side of the seat and parallel therewith. These bars

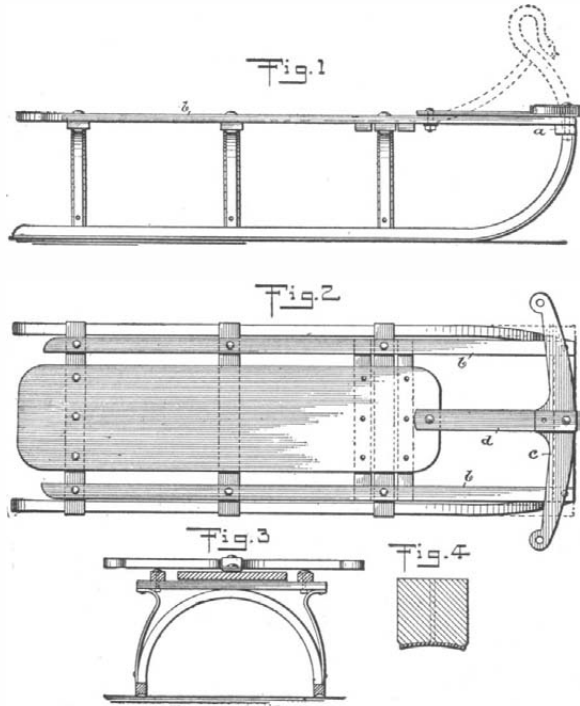

A DIRIGIBLE SLED.

are fastened to all the standards of the sled. On the front bar is fastened a steering lever *c*, which is fulcrumed by the rearwardly-extending arms *d* to the front part of the seat of the sled. It is now evident that when the operator wishes to steer to the right, he presses the lever with the left foot, and *vice versa*. As the steering lever is thus moved, it will be noticed that it moves the transverse bar to one side or the other, thereby curving the runners in the same direction, which will then follow smoothly in the curved tracks.

It will be noticed from the plan view, Fig. 2, that the end standard is bolted to the seat of the sled, and that the other two standards are not, so as to allow a free movement of the runners when operated upon by the steering lever.

Two pieces of wood should be fastened under the seat, a short distance each side of the forward standard, to allow for side movement.

The old iron shoes on the wood runners should be taken off and curved or hollowed as shown in Fig. 4, or may be replaced by new ones. By referring to Fig. 12, it will be seen how this curving of the shoe may be accomplished. A shallow groove is made in a block of hard wood, over which the thin steel shoe is placed. A short piece of round iron is laid on the shoe top; the latter is then hammered into the groove, assuming the hollowed or concave form.

Rivet the shoe on the runner, which should be hollowed out a little to fit. The object of the concave form of runners is the same as that of hollow ground skates. The outside edges have a tendency to dig into the ice or snow, and keep the sled in its course, or in "the same rut"; but when thrown out of line with the steering lever, they seem to take hold of the snow and change the course of the sled.

#### THE HAND MOTOR SLED.

The motor sled, which should appeal to almost any boy, is made by combining a flexible sled with an ordinary hand car, such as sold by toy dealers. The rear wheels are taken off and substituted for a pair of traction wheels, which may be thrown in or out of com-

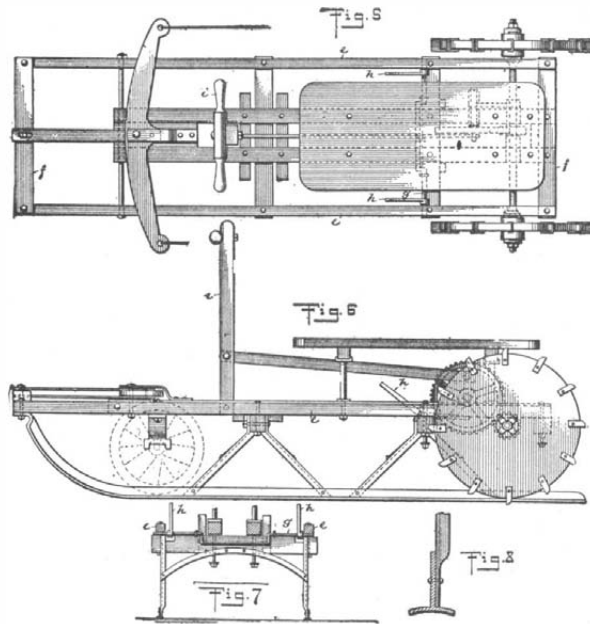

THE HAND-MOTOR SLED.

mission by a suitable lever, within the reach of the operator.

The sled may be of any steerable kind now on the market, or it can easily be built by almost any amateur, to suit the hand car to be used. The material may be bought from almost any hardware dealer. The runners are made for an ordinary size sled, from  $\frac{1}{2}$ -inch by  $\frac{5}{8}$ -inch T iron or steel, or they may be made from two angle irons riveted together. The base of the T should be bent or curved downward, so as to make it slightly dished out in the center. This can be done as before described. See Fig. 12.

The runners are now ready to be bent to suit the height of the sled. There may be two or more standards, according to the length of the sled. They can be made of angle iron, riveted to the runners, and fastened to transverse bars of wood at the top, and braced together if found necessary, so as to make them stiff.

To these standards are fastened, one on each side, and directly on top of each respective runner, wooden rails *e*. These rails are fastened together with transverse bars *f*, at the front and rear ends. Directly over the rear standard, and journaled into the outside rails *e*, is a crankshaft *g*, provided with suitable handles *h*. At the front end, and directly over the front axle, the steering lever is fulcrumed, and two extending arms fastened thereto, which are connected with the front bar *f* by a bolt passing through slots in the arms.

The sled is now ready to receive the hand car, which is placed in the center of same. The front end is fastened to the outside rails *e* with a long bolt, forming a hinge for the car.

Long bolts with nuts at their lower ends are now passed through the frame of the car into the rear transverse bar, also into the rear standard. Two pieces of wood may be nailed or screwed to the rear

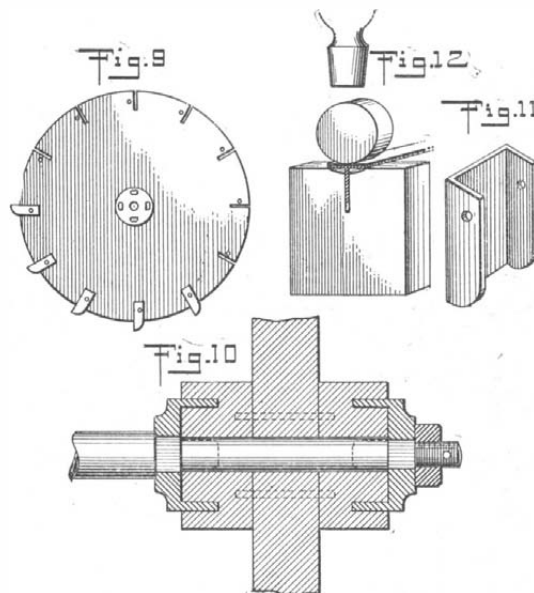

DETAILS OF THE MOTOR SLED.

standard, forming a guide for the up-and-down movement of the car.

It will now be seen that by moving the handle *h* to the rear, the crank *g* will lift the rear end of the hand car relatively to the sled, thereby elevating the traction-wheels from contact with the ice or snow. It will also be seen that the handle *h*

will rest on top of the standard, and that the crank *g* has passed the center of the shaft, and is consequently locked in this position.

The traction wheels are made of hard wood. First cut out a disk (see Fig. 9) about the same size as the wheels of the car. Then cut a number of radial slits in the periphery of same, into which are inserted small galvanized-iron buckets, shown in Fig. 11, and riveted thereto. Small round disks are now fastened to either side of the large disk, so as to make the proper length of the hub. Into these small disks are made four elongated recesses, to fit the four outward-extending prongs of the fixed collars on the shaft; and when screwed together with the nut on the outer end thereof, will keep the large disk fast on the shaft, and will rotate with same. See Fig. 10.

The sled may be propelled by operating the handle *h*, and steered by means of the foot-lever, like the sled described above.

It will be possible to propel the sled up a hill, or go a round-about way to get there. Then by throwing the lever *h*, the traction wheels may be elevated above the runners, so they will not interfere with coasting down hill.

### MENDING A CRACKED BOTTLE.

BY W. J. C.

A very neat way to mend a piece of cracked glass-ware with sodium silicate or water-glass came to my notice some weeks ago. A cut glass decanter which the owner valued very highly had a bad crack running irregularly around the bottom and partly up the side. In addition to preventing its use, it rendered it unsightly.

To remove all appearance of the crack, the decanter was warmed slowly and then sealed with its own ground stopper. The water-glass was then applied with a broad brush on the outside of the crack, and as the air cooled inside the external pressure forced it

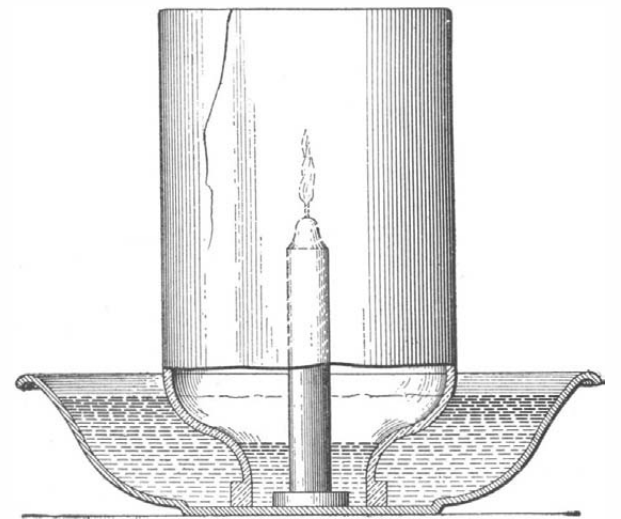

MENDING A CRACKED BOTTLE.

into the crack, which completely disappeared and was rendered perfectly water tight to cold water at least.

Since seeing the above I have tried the same operation with success on a wide-mouthed jar, but obtained a much better vacuum and therefore better results without heating the jar.

I took a deep basin, and in the center arranged a candle as shown in cut. The basin was then filled with water and the cracked jar inverted over the lighted candle; as the air in the jar was consumed by the candle, it was slowly lowered into the water which effectively sealed it. The water-glass was then applied as in the previous operation and the whole left to harden. The water-glass takes six to eight hours to set and then the outside of the bottle or jar can be washed with a cloth dipped in hot water to remove all superfluous water glass.

### A HYDRAULIC TEST FOR THE BOILER.

BY A. C. LAURENCE.

Some time ago my boiler engine was frozen up in a cold snap, and I wished to give my boiler a hydraulic test before steaming up again, to see if it was fit for business. I had no force pump or apparatus of any kind, yet I tested the boiler to the desired pressure, 100 pounds. I have had conversations with engineers since then, and not one of them could tell me how to make such a test without any apparatus, so I believe the idea may be useful for Handy Man's Workshop. I filled the boiler completely with water, leaving no air space whatever, then built a small fire under the boiler, and as the cold water warmed up and expanded, I watched the pressure gage rise until it reached the desired testing pressure, when I opened one of the try cocks, allowing a small quantity of water to escape and relieve the pressure. Having found things O. K., I drained water from the boiler to the proper level and proceeded to get up steam.

RECENTLY PATENTED INVENTIONS.

Pertaining to Apparel.

TROUSERS-EXPANDER.—J. SARGH, New York, N. Y. The expander holds the trousers expanded at the inner sides of the wearer's limbs to hide the bow-legged formation, the expander being actuated in a very simple manner from the crotch of the trousers when the wearer is in an erect position, and the expander collapsing when the latter is in sitting position.

BANDAGE-SUPPORT.—C. M. COOKE, New York, N. Y. This bandage is in the form of bands or ribbons wound around the leg of a person afflicted with varicose veins and other ailments. The inventor provides a support for holding the bandage of the type mentioned securely in place, to prevent the bandage from slipping on the leg, and thus allow the bandage to properly fulfill its legitimate functions to the fullest advantage.

Electrical Devices.

MEANS FOR CLOSING AN OPEN TELEGRAPH-CIRCUIT AT A DISTANT KEY.—C. B. JEWELL, La Junta, Colo. The main feature here consists in the provision at a terminal office of an extra switch and circuit, and an extra battery of such higher voltage than the ordinary working batteries that when the battery of higher voltage is switched on to the live wire it will force its current through the resistance around any open key and, by working the relay of that key, apprise the forgetful operator at that station that he has left his key open and thus instruct him to close it.

APPARATUS FOR RECEIVING SUBMARINE SIGNALS.—C. H. MUNDY, Metuchen, N. J. The invention belongs to a class that possesses all the advantages of the others, the same consisting of a sound transmitter exposed directly to the sea and accessible from within the ship, and is distinguished from other inventions of this class in that the transmitter proper may be removed and replaced while the ship is afloat without taking water within the ship.

Of Interest to Farmers.

HARVESTING-MACHINE.—W. LIVTSCHAK, St. Petersburg, Russia. It is rendered possible by this inventor to heap or pile the cut crop in a space on the frame between the main wheel and the finger bar to discharge same in definite heaps upon the ground so that free space is left for the path of the draft animals, and the subsequent binding up into sheaves by hand is facilitated.

Of General Interest.

APPARATUS FOR BUILDING CONCRETE AND OTHER LIKE STRUCTURES.—W. C. POLK, Fort Branch, Ind. Means provide for supporting the forms independently of the concrete, whereby the green concrete will not be strained or broken by the weight of the forms or by removing the forms after the concrete has set; also for releasing and re-setting the forms for repeated elevations as the building of the walls proceeds, whereby the same forms are continually used, and saving time and labor; and to support the forms that they will be held plumb and level and require no more attention in this respect after the support has once been properly set.

WINDOW.—A. C. GODDARD, New York, N. Y. The window has a swinging or a transom sash arranged to insure a tight joint, to render the window dust and moisture proof when closed. The window frames and sashes can be constructed of sheet metal in a very simple and exceedingly durable manner.

METHOD OF MANUFACTURE OF ROSIN SOAP AND THE LIKE.—A. W. CARMICHAEL, Savannah, Ga. In the present patent the invention is an improved method for dehydrating a saponified solution of rosin commonly called "wet pulpy size," in the production of hard rosin soap, which is more especially used by paper mills in the so-called sizing or waterproof process.

Hardware.

TRIM-FASTENING.—A. C. GODDARD, New York, N. Y. The invention pertains to metal doors, windows, base boards, and like structures, and its object is to provide a trim or molding fastening, more especially designed for securely and quickly fastening trimmings or moldings in place without the use of screws, rivets, or similar fastening devices, and without showing exterior projections, holes, marks, or the like.

GRAVITY-LOCK FOR WINDOWS.—A. C. GODDARD, New York, N. Y. The object of this improvement is to provide a lock arranged to automatically lock in case of fire when the sash is closed by fusing of the chain link connection, to securely hold the window locked and to allow convenient and quick unlocking of the window sash and opening the same.

PLUG FOR REPAIRING HOSE.—A. L. MONAGHAN, Houston, Texas. The object here is to produce a plug which is especially adapted for use in repairing a puncture or perforation in a hose. More particularly the object is to give the plug a form that will facilitate its introduction into the puncture, and which will operate to insure that the plug will remain in position.

Household Utilities.

CLOTHES-HANGER.—J. G. MADLAND, Port Angeles, Wash. A purpose in this case is to provide a clothes reel or rack having revoluble action and which can be dropped down to be loaded or unloaded, and which can be readily carried up and secured in an upright position for drying purposes.

CURTAIN-FIXTURE.—J. E. BOSLER, Olean, N. Y. The invention provides a fixture which provides means for supporting curtain poles and shade rollers. Further, it provides a device for use in holding and supporting curtain poles and shade rollers, and adapted to be adjusted to permit its use in connection with poles and shade rollers of different sizes.

Machines and Mechanical Devices.

REEDING-MACHINE.—O. SCHULER and R. GLASER, Paterson, N. J. The machine is particularly useful in warping or harnessing looms for weaving textile fabrics. An object of the invention is to provide a machine by means of which the warp threads used in textile looms can be easily and expeditiously inserted in the slits of reeds used in connection with these looms.

Designs.

DESIGN FOR A PEN-BOX, DESK-TRAY, AND PAPER-WEIGHT.—C. R. SMEAD, Hastings, Minn. The ornamental design for a pen box, desk tray, and paper weight, comprises an oblong, square cornered, and flat topped article with its lower half having a slightly receding base marked or fluted with a continuous row of ornamental indentations.

NOTE.—Copies of any of these patents will be furnished by Munn & Co. for ten cents each. Please state the name of the patentee, title of the invention, and date of this paper.

Legal Notices

PATENTS

INVENTORS are invited to communicate with Munn & Co., 361 Broadway, New York, or 625 F Street, Washington, D. C., in regard to securing valid patent protection for their inventions. Trade-Marks and Copyrights registered. Design Patents and Foreign Patents secured.

We undertake all Patent, Trade-Mark and Copyright Practice, both before the Patent Office and the Courts, and we have special facilities for handling Infringement and other suits in Federal and State jurisdictions.

A Free Opinion as to the probable patentability of an invention will be readily given to any inventor furnishing us with a model or sketch and a brief description of the device in question. All communications are strictly confidential. Our Hand-Book on Patents will be sent free on request.

Every patent secured through us receives special notice in the Scientific American. Ours is the Oldest agency for securing patents; it was established over sixty years ago.

MUNN & CO., 361 Broadway, New York Branch Office, 625 F St., Washington, D. C.

INDEX OF INVENTIONS

For which Letters Patent of the United States were Issued for the Week Ending January 12, 1909, AND EACH BEARING THAT DATE [See note at end of list about copies of these patents.]

Table listing inventions with patent numbers, including items like Acid, apparatus for making sulfuric acid, Adjustable hanger, Downing & Duley, Aerial ropeway, C. W. Henry, Air brake system, H. W. Ley, Air compressor, variable volume, M. Kurth, Air heater, A. Mathias, Air ship, W. Rumble, Alloy, J. F. Clapp, Amusement apparatus, E. Woerth, Amusement slide, W. S. Tothill, Animal trap, G. C. Biddle, Annunciator, E. J. Brandt, Arsenophenol, Ehrlich & Berthelm, Automobile spring, L. S. Chadwick, Automobile steering wheel, A. J. Kinnucan, Automobile wind shield, H. H. White, Awl, sewing, A. M. Parker, Axle oiling device, L. Damour, Bag, J. D. O'Brien, Baling press, Neumann & Dunham, Baling press, W. O. Cumming, Balloon or air ship, A. F. Godfrey, Barrel trussing machine, Sullivan & Young, Bath tub and cabinet, combined, C. W. Peterson, Bath tub waste and overflow connection, J. F. Eichenlaub, Battery discharge regulator, E. J. Murphy, Battery plate, G. B. Rinehart, Battery, secondary, L. H. Flanders, Beating engine, A. Muirhead, Bed, spring, W. E. Frank, Bed spring, J. H. & L. S. Zelders, Bedstead mattress or bottom attachment, S. W. Bennett, Beet harvester, W. Kite, Beet topper, Giddings & Blevins, Bell, See Electric alarm bell, Belt buckle, H. L. Perryman, Belt carrier, C. Miller, Belt coupling, J. C. Cottle, Bench clamp, I. Solberg, Billiard marker, etc., H. R. Wildish, Billiard table, F. Hepton, Bin, Cameron & Randolph, Binder or loose sheet holder, temporary, Pink & Petty, Block signal system, F. B. Corey, Boat, hydroplane, L. E. Simpson, Boiler lug, M. M. Hedges, Boiler scale removing apparatus, A. Schror, Boiler setting, D. F. Kilgour, Boiler stand, range, C. H. Foster, Bolt clipper, H. K. Porter, Book, instruction, J. D. Thompson, Boot and shoe insole, G. W. Belonga, Boring apparatus, deep, W. Schott, Bottle, non-refillable, S. Gardner, Bottle washer, Arndt & Marquart, Bottling machine crown branding attachment, Gilmore & Mulkey, Box, general, N. Dahl, Box strap and bale tie, A. A. Patzlaaf, Brake shoe, G. A. Woodman, Brake shoe, H. Lewis, Brake shoe, A. L. Streeter, Bridle bit, J. Cummings, Brush, A. H. Wolcott, Brush, rotary, H. Nielson, Bucket, H. Troeger, Buckle, A. C. Stone, Buckle and clasp attaching means, H. Gibson, Burglar alarm, H. Wettstein, Burglar alarm, C. E. C. Eddy, Butter compound making, J. E. Garrette, Butter, making, C. G. Johnson, Button, E. R. Hoppler, Cable hanger, C. L. Peirce, Jr., Calculating device, S. R. Lamb, Calendar, W. H. Hall, Calendar frame and card, W. H. Hall, Can, C. Rucht, Canning operations, machine employed in, G. G. Glass, Car automatic air and gas valve, W. D. McPherson, Car brake rigging, railway, W. H. Sauvage, Car center bearing, L. W. Barber, Car construction, passenger, F. M. Brinckerhoff, Car, dumping, S. Ketchum, Car dumping apparatus, mine, Hubard & Adams, Car end framing, A. E. Ostrander, Car fender, J. D. Wright, Car friction draft rigging, railway, J. F. O'Connor, Car, grain, G. R. Dunn, Car jack, suspension, A. O. Brill, Car, passenger, Curwen & Smith, Car, passenger, E. Babin, Car seat, Budd & Condo, Car step, extension, E. W. Fuhr, Car, two-way dump, A. E. Ostrander, Car underframe, W. P. Bettendorf, Cars to the floor level, automatic device for bringing hydraulic elevator, I. B. Ritter, Carburer, W. C. Westaway, Card holder, illustrated post, E. O. Williams, Card rack, E. O. Williams, Carpet sweeper, O. R. Chaplin, Cart, combination, O. & M. Helgeson, Casting for light fixture stems, P. J. Handel, Cash register, H. S. Hallwood, Casks, device for planing the rims of, L. Drexler, Caster, J. E. Johnson, Catamenial bandage, Treber & Simon, Cattle stanchion, W. B. Crumb, Cellar spray, detachable, J. F. Oliver, Cement buildings, waterproofing paint for Portland, T. A. Edison, Cement structures, waterproofing paint for Portland, T. A. Edison, Chair, See Nursery chair, Child's back rest, L. F. Pullman, Chimney, M. E. Howe, Chimney pot, T. B. Cullen, Christmas tree holder, W. A. Mitchell, Chuck, rivet holding, Sassemann & Dalin, Cigar box, A. B. Smith, Cistern cleaner and water purifier, Murray & Kimball, Clay, etc., machinery for preparing or treating loam, P. Baur, Clock, E. F. Herschede, Clock, electric secondary, Jackson & Vizents, Clock, electric secondary, H. C. Vizents, Clock, electric self-winding, Jackson & Vizents, Clock mount, H. J. Keating, Clock, self-winding, C. W. Wagner, Clock system, E. E. Yaxley, Cloth, etc., machine for cutting lengths of, F. W. Denison, Cloth or other material, machine for trimming and cutting lengths of, F. W. Denison, Clothes drier, G. N. Galloway, Clutch mechanism, J. Maitland, Cock for flushing tanks, ball, W. H. Perkins, Cock, stop, A. D. Herschler, Cock, three-way, E. H. Gold, Coffee pot, China, C. F. Blanke, Coin operated releasing mechanism, G. P. Brand, Coin operating mechanism, Symonds & Brann, Collar dampening and burnishing machine, Currier & Letschuh, Color and making same, sulfur, E. S. Chapin, Color and making same, sulfur, E. T. Bundsman, Comb, sanitary, H. T. Moler, Composition board, J. Ferla, Composition for antiseptic and other purposes, H. S. Blackmore, Composition of matter, J. Laeuffer, et al., Concrete metal reinforce, G. F. Dodge, Concrete mixer, A. D. Hadsel, Concrete tie, reinforced, W. Dunson, Condenser, G. M. Newhall, Condiment holder, H. J. McWilliams, Conical, sectional, W. G. Wright, Converter, J. B. Dentthorn, Conveyor belt support, E. E. Vrooman, Cooking utensil cover, C. J. Cooling, Cooler, S. M. King, Coop or crate, O. J. La Bauve, Corn gatherer and husker, E. C. Dean, Corn separator, seed, C. F. Asplund, Cot, collapsible, C. B. Lamb, Cotton chopper, P. Harrison, Cotton cleaner, A. L. Treese, Counting device, D. L. Roscoe, Cradle crusher, B. K. Donald, Crane mechanism, D. Kendall, Crate or case, shipping, J. M. Porter, Crown for winding stems of watches, H. Axtell, Crusher, De Wind & Hughton, Crutch, adjustable, G. S. Rhodes, Crutch tip, E. H. Seibert, Culinary utensil, H. B. Seely, Cultivator, O. Caron, Cultivator, W. J. Asbell, Cup shaped articles, apparatus for making, W. H. Smith, Cupola attachment, C. J. Langhorst, Current motor, alternating, M. C. A. Latour, Currycomb, J. Oisafskie, Curtain fixture, P. A. Houghtaling, Cut off, A. L. Rosene, Cutlery grinder, H. E. Sweet, Cutter bar, E. F. McElwee, Cutter head, E. F. Bengler, Cycle handle, W. C. Mead, Dampener regulator, W. M. Fulton, Dental implement, C. C. Murray, Dental stool or the like, W. H. Reynolds, Die head, automatic, Brown & Sprink, Dish washing machine, C. W. Jaycox, Display rack, J. F. Biedy, Door check, C. F. Dorn, Door construction, sliding, J. R. Hussey, Door opener, F. Conner, Double rake, R. M. Kenney, Draft equalizer, H. J. Helder, reissue, Dredging apparatus, J. Carlesimo, Drying, C. W. Volney, Drilling engine, rock, J. A. Traylor, Driving mechanism, sliding friction, A. A. De Loach, Drum, winding, F. Donaldson, Dust collector, H. A. Knos, Dye and making same, anthracene, M. H. Dye and making same, sulfur, E. S. Chapin, Dye and making same, sulfur, E. S. Chapin, 909,151, 909,152, 909,154, 909,155

Table listing inventions with patent numbers, including items like Electric alarm bell, N. Kessler, Electric alarm, thermo, Paul & Stewart, Electric fuse, L. W. Downes, Electric machine brush holder, dynamo, M. Walker, Electric machine, dynamo, B. A. Behrend, Electric machine, dynamo, M. W. Mackie, Electric machines, means for starting dynamo, W. D. Pomeroy, Electric signaling, selective, A. H. Nicholson, Electric trap for rats, etc., J. T. Norris, Electrical driving mechanism, G. C. Marx, Electrical impulse transmitting device, J. Erickson, Electrode or pencil for arc lights, I. Ladoff, Electrotype plates, bending, B. F. Upham, Elevator, Sherren & Mason, Elevator safety device, C. Paradis, Elevators and other movable objects and bodies, appliance for, A. Lungen, Embroidering machine fabric roller, A. Saurer, Engine, See Beating engine, Engine admission valve, gas, G. B. Petsche, Engine bed plate, beater, R. A. North, Engine starting apparatus, explosive, L. M. Booth, Engine valve gear, C. F. Prescott, Engine valve gear, steam, A. Hossfeld, Ether, santalol, J. Calsen, Excavator, W. S. Smith, Exchange switching device, party line, W. Hagstrom, Extension bolt, C. F. Schwing, Eyeglass case, A. W. Farrington, Fabric, N. L. Duryea, Fare register, J. Lindhart, Feed mill, R. S. Tomkinson, Feeding device for machine tools, etc., C. A. Hirth, Fibers and fabrics, waterproofing, T. A. Edison, Fibers, treating vegetable textile, A. E. M. Rousseau, Fibrous material, securing together surfaces of, J. R. Harbeck, Fifth wheel, R. G. & L. Cator, File case or cabinet, E. G. Minder, Filing case, C. Zoerb, Film roll holder, adjustable, W. J. Bresnan, Firearm with cylindrical breech, semi-automatic, B. Goebel, Firearms, breech mechanism for self-loading, L. Schmeisser, Fish hook holder, snelled, C. F. West, Filer, W. Knowles, Floor scraping machine, G. S. Newman, Floor scraper, J. L. Hearing, Flooring clamp, A. A. Hendrickson, Flower pot, E. Bade, Flush tank, J. O. Broussard, Flushing tank, H. S. Hawks, Folding box or crate, H. L. Guilline, Fruit, apparatus for use in the treatment of, J. C. L. Campbell, Fruit cutter, A. J. Brunson, Fruit sorter, A. D. Huntley, Fruit, treating, J. C. L. Campbell, Fruits or vegetables, preserving, A. Huch, Fuel, artificial, J. W. Leadbeater, Furnace, G. Prescott, Furnace, A. Wardzinski, Furnace, W. Dodge, Furnace, Jackson & Alkner, Furniture, folding, W. Rabich, Furniture, hollow sheet metal, F. B. Burns, Furniture joint for wooden structures, A. N. Webb, Furniture structure lock clamp, knockdown, W. C. Dolcater, Fuse and fuse block, portable, G. A. Drucker, Game apparatus, J. Baust, Game apparatus, D. H. Talbert, Game apparatus, W. L. Fross, Gas burner, A. F. Thompson, Gas burner, safety, J. H. Ahlgren, Gas generator, acetylene, W. E. Shreffler, Gas heater automatic cut off, H. A. Koening, Gas meter connecting device, Gray & Stevens, Gas producer, C. L. Straub, Gas producer, P. G. Schmidt, Gate, I. Lester, Gear tooth chamfering apparatus, R. B. Weaver, Gears, etc., upon shafts, machine for removing from and replacing, C. Remelius, Glassware, making machine footed, J. I. Arbogast, Grain drill, A. Bellerive, Graining compound, F. M. Clapp, Grate, D. W. Cherry, Grinder, H. G. McCulloch, Guide for hemming, B. & G. Branower, Gun, automatic, Dawson & Buckham, Gunpowder, smokeless, C. P. H. Claessen, Hand bag, A. Staeger, Handle, See Cycle handle, Hank dyeing machine, J. H. Ashwell, Hay carrier, F. S. Polley, Hay sling, lock, A. P. Boyer, Heating surface, hot air, D. S. Richardson, Heating system, vapor, J. D. Arnold, Hinge, detachable, J. F. Melton, Hog ring, R. Roethlisberger, Hook and eye, W. M. Corthell, Horse and cattle water bowl, automatic, P. A. Cheevers, Horse detacher, M. S. January, Horseshoe pad, J. Dillon, Hose coupling, J. J. Antic, Hose coupling, B. L. rgan, Hose supporter, H. W. Richardson, Hydrocarbon burner, P. M. Keller, Hydrocarbon motor, Winkley & H., Hydrogen, composition of matter for generating, G. F. Brindley, Ice cream mold, T. Cohn, Ingot, etc., casting apparatus, W. J. Evans, Ingots, solidifying, E. P. Cuiat, Inkstand, W. H. Wetmore, Insulated rail joint, E. F. Schermerhorn, Insulators, screw press to form, Hemingray & Hawk, Internal combustion engine, F. W. Brady, Internal combustion engine, C. R. Daellenbach, Jack, J. W. Carlson, Ketone sulfoxylate and making same, A. Stock, Knife handle polishing machine, W. J. Carney, Knitting machine thread controlled stop motion, circular, N. H. Williams, Knitting mechanism, L. B. Wygant, Ladder, H. A. Myers, Ladder, step, Reed & Spooner, Ladder, step, J. B. Robertson, Ladle crane mechanism, D. Kendall, Ladle, swinging, W. R. Palmer, Lamp, A. W. Hall, Lamp, incandescent, M. M. Merritt, Lamp prism, electric, J. C. Zubli, Lamp receptacle, electric, Patterson & Farrell, Lamp, safety, N. B. Ippolito, Lamp, therapeutic, E. W. Locke, Lamps, exhausting, M. M. Merritt, Lap joint and nut lock, continuous, Gash & McDavit, Last, A. G. Fittz, Last support, A. G. Fittz, Lath holder, J. F. & H. L. Presba, Lath machine, Bergren & Moan, Leather, enameling, B. B. Goldsmith, Leather splinting machine, A. A. Chilson, Leaves, swinging display, A. M. Parks, Leg guard for athletes, Pierce & Nickerson, Letter tying device, B. P. Greenwood, Letters and other characters, apparatus for manufacturing, T. J. Wallace, Leveling instrument, A. Blair, Light distributing device, Pearson & Pierce, Light sensitive layer carriers, device for exposing, J. Schmueck, Liquid controller, Shields & Cox, 909,192, 909,819, 909,564, 909,834, 909,136, 909,197, 909,216, 909,651, 909,814, 909,631, 909,383, 909,428, 909,832, 909,695, 909,322, 909,433, 909,826, 909,214, 909,653, 909,140, 909,665, 909,302, 909,541, 909,700, 909,409, 909,462, 909,356, 909,379, 909,625, 909,348, 909,300, 909,168, 909,457, 909,590, 909,755, 909,440, 909,734, 909,534, 909,398, 909,233, 909,722, 909,426, 909,652, 909,406, 909,408, 909,843, 909,537, 909,789, 909,586, 909,754, 909,145, 909,413, 909,542, 909,600, 909,626, 909,218, 909,767, 909,801, 909,820, 909,540, 909,720, 909,561, 909,165, 909,520, 909,708, 909,779, 909,711, 909,508, 909,698, 909,308, 909,179, 909,345, 909,690, 909,194, 909,719, 909,671, 909,842, 909,137, 909,847, 909,756, 909,316, 909,533, 909,849, 909,546, 909,248, 909,513, 909,091, 909,141, 909,672, 909,737, 909,436, 909,229, 909,554, 909,282, 909,420, 909,287, 909,131, 909,200, 909,824, 909,190, 909,728, 909,536, 909,550, 909,570, 909,556, 909,491, 909,458, 909,595, 909,531, 909,558, 909,364, 909,703, 909,544, 909,727, 909,272, 909,315, 909,669, 909,825, 909,605, 909,655, 909,785, 909,812, 909,507, 909,326, 909,415, 909,627, 909,811, 909,580, 909,358, 909,217, 909,139, 909,288, 909,157, 909,210, 909,215, 909,399, 909,487, 909,529, 909,447, 909,459, 909,340

Liquid evaporating apparatus, J. L. Schrade. 909,460  
 Liquid level apparatus, differential, E. P. Noyes. 909,206  
 Liquid supply, means for automatically controlling, T. Wilmore. 909,355  
 Loading and unloading apparatus, J. W. Reynolds. 909,222  
 Location indicator, F. Hoffmann. 909,798  
 Lock indicator, F. E. Smith. 909,829  
 Locking device, M. Williams. 909,726  
 Logging device, C. H. Starbird. 909,250  
 Loom, Rhoades & Stimpson. 909,821  
 Loom let off motion, H. Herzberg. 909,596  
 Loom picker, O. Poitras. 909,333  
 Loom shuttle, W. F. Draper. 909,377  
 Loom shuttle, Draper & Northrop. 909,771  
 Loom warp stop motion, A. E. Rhoades. 909,822  
 Lubricator, L. T. Dery. 909,162  
 Mail bag catcher, J. S. Peck. 909,589  
 Mail bag catcher and deliverer, J. H. Knight. 909,611  
 Mail bag delivering and receiving apparatus, C. Della. 909,371  
 Mailing package, A. S. Pierson. 909,330  
 Mangle, S. Moe. 909,312  
 Manure and alkali salts, manufacture of, A. Vasseux. 909,350  
 Manure pulverizer and loader, J. N. Frost. 909,576  
 Massage apparatus, vibratory, E. N. Slipperley. 909,828  
 Massaging device, M. Fisch. 909,571  
 Match box, E. L. Hembree. 909,407  
 Match box and cigar cutter, combined, H. L. Farrow. 909,852  
 Match safe and cigar cutter, combined, J. N. Mitchell. 909,441  
 Mattress, wire, G. B. Smith. 909,244  
 Measuring apparatus, F. James. 909,188  
 Measuring line, G. H. Prier. 909,668  
 Measuring stand, revolving, C. E. Thies. 909,258  
 Meat, preserving, R. Emmerich. 909,172  
 Metal harness, W. A. Kuhlman. 909,612  
 Metal pipe, producing, G. D. Dorsey. 909,376  
 Metal plates, machine for forming bars or rounds from, S. McCloud. 909,644  
 Metal sheet prepared for punching, J. R. Harbeck. 909,589  
 Metal sheet piling, M. W. Cluxton. 909,549  
 Metal sheet piling (junction unit), M. W. Cluxton. 909,548  
 Metals, coating with, C. H. Zieme. 909,274  
 Micrometer, E. J. Lees. 909,623  
 Micrometer caliper square, F. S. Buckminster. 909,538  
 Milk separating and butter churning process, G. A. Davidson. 909,763  
 Milking machine, C. H. Seymore. 909,239  
 Mill, See Feed mill.  
 Mixing and straining machine, W. S. Fern. 909,306  
 Monkey wrench, folding, J. P. Nikonow. 909,205  
 Mop head, F. W. Pendergast. 909,449  
 Mop wringer, W. Moffat. 909,442  
 Motor for portable grain dumps, hydraulic, J. E. Camp. 909,278  
 Motor for wagon dumps, hydraulic, J. E. Camp. 909,280  
 Motors, apparatus for the magnetic ignition in explosion, G. A. Unterberg. 909,483  
 Motors, governing device for two stroke cycle internal combustion, G. W. Thornton. 909,256  
 Music leaf turner, A. Friedrichs. 909,391  
 Music leaf turner, A. T. Ziegler. 909,505  
 Music rack, Watkins & Kempf. 909,489  
 Muzzle, calf, C. H. Patterson. 909,212  
 Napkin and supporter, E. C. Rink. 909,674  
 Nursery chair, H. H. Collings. 909,758  
 Nut, lock, E. B. Wiles. 909,495  
 Nut, lock, W. F. Harris. 909,788  
 Nut, lock, J. J. Moran. 909,637  
 Nut, lock, A. Swanson. 909,706  
 Oil burner, crude, J. W. Parks. 909,323  
 Oil can, F. P. Brennan. 909,747  
 Optical illusion device, F. C. Perkins. 909,450  
 Ore concentrator driving mechanism, E. Deister. 909,765  
 Ore grinding machine, G. A. Denny. 909,286  
 Ore treating machine, J. W. R. Laxton. 909,429  
 Ores and tailings, amalgamator and concentrator for, J. R. Harrison. 909,293  
 Ores, obtaining nickel from silicious, E. F. Price. 909,666  
 Ores, reducing, J. Herman. 909,795  
 Ozone generating apparatus, W. Kollé. 909,309  
 Packer, bottom hole, C. M. Heeter. 909,593  
 Packing box, M. H. Longfellow. 909,628  
 Packing, fluid pressure, Parsons & Turnbull. 909,324  
 Paper folding machine, J. H. Adams. 909,841  
 Paper punch, A. M. Barrett. 909,739  
 Paper roll carrier, guide, and cutter, C. R. Hotchkiss. 909,599  
 Paper trimmer, C. T. Ridgley. 909,227  
 Papers, apparatus for collecting, folding, and wrapping, W. A. Tompkins. 909,712  
 Pea separator, A. L. Hamacek. 909,587  
 Pen, fountain, F. E. Waterman. 909,262  
 Pen, writing, W. H. Schweizer. 909,236  
 Phonograph, magazine, C. Reinhardt. 909,455  
 Phonograph records, H. Schroder. 909,461  
 Phonograph record disks, album for, B. Hirsch. 909,410  
 Piano pedal mounting, H. Sandner. 909,683  
 Piano valve mechanism, autopneumatic, J. Skubis. 909,242  
 Picture lifter, E. M. Wollam. 909,729  
 Picture machine, moving, A. F. Hamacek. 909,404  
 Pin holding and dispensing device, L. F. Woodhead. 909,270  
 Pipe coupling, J. M. St. John. 909,830  
 Pipe ferrule, J. R. Williams. 909,725  
 Pipe turning apparatus, E. E. Williams. 909,724  
 Pipes, device for removing burs from, C. A. Hart. 909,182  
 Pistol, toy, H. D. Gardy. 909,393  
 Placer mining machine, A. L. Corson. 909,553  
 Platen press automatic register gage, H. E. Staniford. 909,249  
 Plow, T. D. Sims. 909,241  
 Plow, C. B. Clark. 909,848  
 Plow, snow, A. Horn. 909,301  
 Plumb-bob and chalk-line holder, W. N. Caviler. 909,846  
 Porcelain facing locking device, Poole & Hefflinger. 909,662  
 Pouch swing, G. P. & B. N. McEntire. 909,317  
 Potato digger, W. H. Berling. 909,521  
 Potato gathering machine, J. Dolman. 909,375  
 Potato picking machine, S. Geigel. 909,581  
 Potential starter attachment, H. W. Cheney. 909,367  
 Powdered materials, delivery receptacle for, T. S. Patterson. 909,657  
 Printing frame, photographic, J. C. Morgan. 909,639  
 Printing machinery, J. A. J. Hayes. 909,591  
 Printing plates by means of electrolytic etching, preparing, H. Strecker-Auffermann. 909,831  
 Printing press, R. Miehle. 909,199  
 Printing press, B. F. Upham. 909,260  
 Printing press, F. W. Nelson. 909,776  
 Printing press ink distributor, automatic, W. B. Sheffield. 909,339  
 Propeller, E. D. Spear. 909,246  
 Protractor, C. O. Schellenbach. 909,686  
 Pulley, sheet metal, J. E. Zimmermann. 909,506  
 Pulp articles, apparatus for making, M. L. Keyes, reissue. 12,911  
 Pulverizing machine, H. Besser. 909,275  
 Pump, C. Behn. 909,135  
 Pump, R. C. Bingham. 909,276  
 Pump, G. A. Rockola. 909,676  
 Pump, compound, J. Desmond. 909,193  
 Pump, hydraulic, F. W. Nelson. 909,647  
 Pump, lubricating, F. Stahl. 909,471  
 Pump, vacuum, C. L. Heisler. 909,183  
 Punch, H. Denburger. 909,285  
 Quilting frame, L. A. Ashby. 909,357  
 Rack, See Card rack.  
 Rail rack and traction locomotive, N. D. Levin. 909,430  
 Rail anchor, J. M. Scott. 909,692  
 Rail anchorage, third, W. B. Potter. 909,335  
 Rail chair, E. P. Batchelder. 909,519  
 Rail joint, H. G. Gillmor. 909,177  
 Rail joint, A. Swenson. 909,346  
 Railway car bolster, J. M. Hansen. 909,588  
 Railway controlling and signaling system, electric, H. E. McDonnell. 909,201  
 Railway cross-tie, J. A. Atwood. 909,359



**Engine and Foot Lathes**  
 MACHINE SHOP OUTFITS, TOOLS AND SUPPLIES. BEST MATERIALS. BEST WORKMANSHIP. CATALOGUE FREE  
 SEBASTIAN LATHE CO., 120 Culvert St., Cincinnati, O.

**Foot and Power and Turret Lathes.** Planers, Shapers, and Drill Presses  
 SHEPARD LATHE CO., 133 W. 24 St., Cincinnati, O.

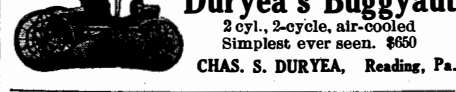

**Noteworthy Articles**  
 ON TIMELY TOPICS  
 Each number of the Scientific American Supplement costs 10 cents by mail.

**SEWAGE AND ITS DISPOSAL.** A review of modern methods. By H. LEMMOIN-CANNON. SCIENTIFIC AMERICAN SUPPLEMENT 1551.  
**ELECTRIC LIGHTING FOR AMATEURS.** How a small and simple experimental installation can be set up at home. SCIENTIFIC AMERICAN SUPPLEMENT 1551.  
**CHEMICAL AFFINITY.** Simply explained by SIR OLIVER LODGE. SCIENTIFIC AMERICAN SUPPLEMENT 1547.  
**CASE HARDENING.** By DAVID FLATHER. SCIENTIFIC AMERICAN SUPPLEMENT 1547.  
**ELECTRIC IGNITION SYSTEMS.** A comprehensive article by E. W. ROBERTS. SCIENTIFIC AMERICAN SUPPLEMENT 1546.  
**CONCRETE.** A general article on its merits and defects. SCIENTIFIC AMERICAN SUPPLEMENT 1543.  
**REINFORCED CONCRETE.** Some of its Principles and Applications with practical Illustrations. SCIENTIFIC AMERICAN SUPPLEMENTS 1547, 1548, 1551.  
**ELECTRONS AND THE ELECTRONIC THEORY** are discussed by SIR OLIVER LODGE in SCIENTIFIC AMERICAN SUPPLEMENTS 1428, 1429, 1430, 1431, 1432, 1433, 1434.  
**THE PANAMA CANAL** is described from the engineering standpoint in SCIENTIFIC AMERICAN SUPPLEMENT 1359.  
**WIRELESS TELEGRAPHY.** Its Progress and Present Condition are well discussed in SCIENTIFIC AMERICAN SUPPLEMENTS 1425, 1426, 1427, 1386, 1388, 1389, 1383, 1381, 1327, 1328, 1329, 1431.  
**HOW TO CONSTRUCT AN EFFICIENT WIRELESS TELEGRAPH APPARATUS AT SMALL COST** is told in SCIENTIFIC AMERICAN SUPPLEMENT 1363.  
**SUBMARINE NAVIGATION.** An exhaustive review of the subject is published in SCIENTIFIC AMERICAN SUPPLEMENTS 1414, 1415, 1222, 1223.  
**SELENIUM AND ITS REMARKABLE PROPERTIES** are fully described in SCIENTIFIC AMERICAN SUPPLEMENT 1430. The paper is illustrated by numerous engravings.  
**THE INTERNAL WORK OF THE WIND.** By S. P. LANGLEY. A painstaking discussion by the leading authority on Aerodynamics, of a subject of value to all interested in airships. SCIENTIFIC AMERICAN SUPPLEMENTS 946 and 947.  
**LANGLEY'S AERODROME.** Fully described and illustrated in SCIENTIFIC AMERICAN SUPPLEMENTS 1404, 1405 and 1546.  
**STEAM TURBINES.** Their Construction, Operation and Commercial Application. SCIENTIFIC AMERICAN SUPPLEMENTS 1306, 1307, 1308, 1422, 1400, 1447, 1370, 1372, 1521. The articles have all been prepared by experts in steam engineering.  
**PORTLAND CEMENT MAKING** is described in excellent articles contained in SCIENTIFIC AMERICAN SUPPLEMENTS 1433, 1465, 1466, 1510, 1511.  
**AERIAL NAVIGATION.** Theoretical and Practical Discussions. Pictures and Descriptions of actually-built dirigible balloons and aeroplanes will be found in SCIENTIFIC AMERICAN SUPPLEMENTS 1161, 1149, 1150, 1151, 1404, 1405, 1413, 1455.  
**THE TANTALUM LAMP.** A full illustrated description of a lamp having a metallic filament and burning at once without preliminary heating appears in SCIENTIFIC AMERICAN SUPPLEMENT 1523.  
**THE WATERPROOFING OF FABRICS** is thoroughly discussed in SCIENTIFIC AMERICAN SUPPLEMENT 1522 by an expert.  
**THE SPARK COIL, ITS CONSTRUCTION AND MAINTENANCE,** is the subject of a painstaking article in SCIENTIFIC AMERICAN SUPPLEMENT 1522.  
**ELECTRIC IGNITERS FOR GAS ENGINES** are discussed in SCIENTIFIC AMERICAN SUPPLEMENT 1514.  
**CARBURETERS,** a subject of immense importance to automobilists and the users of oil engines, is well treated in SCIENTIFIC AMERICAN SUPPLEMENT 1508.  
**EPICYCLIC TRAINS,** which play an important part in toothed gearing, are ably described in SCIENTIFIC AMERICAN SUPPLEMENT 1524.

Each number of the Scientific American Supplement costs 10 cents by mail.

**MUNN & COMPANY**  
 361 Broadway New York

Railway crossing, A. E. Kaltschmidt. 909,189  
 Railway platform guard, H. C. Heffner. 909,791  
 Railway rail joint, Drake & Pierce. 909,770  
 Railway rolling stock against injury means for protecting the operatives of, Lahey & Williams. 909,618  
 Railway smoke and dust arrester, E. V. Estill. 909,384  
 Railway spike, T. J. Akers. 909,509  
 Railway spikes, etc., means for fastening in position, G. Lakhovsky. 909,619  
 Railway switch, E. Rush. 909,682  
 Railway switch structure, H. Theis. 909,710  
 Railway tariffs, circulars, etc., filing means for, Spangle & Parsons. 909,245  
 Railway tie, A. S. Topping. 909,713  
 Railway tie, J. W. Calder. 909,752  
 Railway tie, metallic, J. E. Raby. 909,220  
 Railway tie plate, J. E. Muhlfield. 909,443  
 Railway tie remover, J. H. Rice. 909,225  
 Rake cleaning attachment, horse, E. Weidlein. 909,721  
 Reamer, E. Haber. 909,401  
 Ream or C. H. Malmédie. 90, 84  
 Recording annunciator, W. B. Woodruff. 909,502  
 Reel, H. M. Danker. 909,559  
 Refrigerator or cooler, C. Hinrichs. 909,597  
 Relay, Buchanan & Wiegand. 909,146  
 Revolving and sliding chair, Butcher & Perin. 909,751  
 Ribbon holder, J. W. Beck. 909,522  
 Road construction, Williamson & Brennan. 909,499  
 Road scraper, riding wheel, Robinson & Safer. 909,228  
 Roads, combined mixer and sprinkler for making, E. N. Beard. 909,134  
 Rock for refractory material, reducing, Walker & Croft. 909,835  
 Rod, stem, and shaft compound stuffing-box, O. O. Thwing. 909,479  
 Roll holder, E. O. Bulman. 909,750  
 Rope clamp, N. S. Wheeler. 909,352  
 Rotary engine, F. M. Whitman. 909,493  
 Rotary engine, H. C. Schaefer. 909,685  
 Rotary kiln, M. G. Semper. 909,464  
 Rotary motor, G. W. Flora. 909,774  
 Routing machine cutter-guiding templet, C. W. Montgomery. 909,636  
 Rubber heel, R. T. Elwell. 909,567  
 Rule joint, T. Prentice. 909,819  
 Saddle, A. P. Fachiri. 909,385  
 Safe, O. W. Bedell. 909,523  
 Safe, S. A. Ely. 909,568  
 Safe door, Wilkinson & Mummert. 909,496  
 Sash fastening window, P. H. McGrath. 909,315  
 Sash for hotbeds, etc. W. S. Bodley. 909,361  
 Sash lock, automatic safety, T. J. Gibson. 909,783  
 Sash lock, duplex, W. Lipps. 909,432  
 Sash operating mechanism, W. Sefton. 909,463  
 Sash, reversible window, C. M. Smith. 909,243  
 Saw, automatic wood, T. P. Pye. 909,454  
 Saw, butcher's, T. A. Tubbs. 909,716  
 Saw swage attachment, J. P. Hedstrom. 909,295  
 Scale bar, tabulating, M. C. Mosher. 909,313  
 Scale, computing, J. S. Bradley. 909,745  
 Scale, platform computing, J. S. Bradley. 909,744  
 Scale, price, G. Walker. 909,746  
 Screen, H. J. Sharp. 909,246  
 Screw-driver, S. H. Wiesedeppe. 909,723  
 Seal, E. J. Brooks. 909,363  
 Seals on papers, device for impressing, A. L. Webster. 909,836  
 Sealing band, J. W. Ripper. 909,337  
 Seed planter, Grissel & Haley. 909,289  
 Seeding and drilling machine, T. J. Thorp. 909,478  
 Settling tank, oil, O. Zobler. 909,733  
 Sewer pipe, C. M. Stratton. 909,344  
 Sewing machine looper thread pull-off, R. G. Woodward. 909,839  
 Sewing machine trimming mechanism, R. G. Woodward. 909,840  
 Sewing mechanism and pull-off device therefor, overseaming, R. G. Woodward. 909,838  
 Shade and curtain bracket, combined window, G. W. White. 909,353  
 Shade and curtain holder device, window, T. S. Plikerd. 909,462  
 Shade roller adjustable support, W. J. Winas. 909,269  
 Shade roller bracket, C. Lindquest. 909,195  
 Sharpening machine, A. M. McLean. 909,319  
 Shearing device, automatic, M. Szax. 909,476  
 Shears, C. W. Sprague. 909,470  
 Shears and cigar-tip cutter, combined, A. L. Tolman. 909,347  
 Sheet metal working machine, L. J. Shifley. 909,341  
 Shoe rack tag holder, F. A. Putnam. 909,219  
 Shoe sole, C. K. Sharood. 909,338  
 Shore protector, J. S. Keller. 909,423  
 Shutter lock, portable, J. L. Lenton. 909,825  
 Shuttle mechanism, A. C. Roebuck. 909,877  
 Sieve, adjustable, C. Cloz. 909,757  
 Sifter, flour, I. M. Newell. 909,649  
 Signal apparatus, C. J. Coleman. 909,551  
 Signature feeding and assembling machine, D. G. Smyth. 909,701  
 Skylight and ventilator, combined, B. G. Steele. 909,472  
 Sled runner, C. M. Ford. 909,775  
 Sleigh or go-cart, convertible, H. E. Parker. 909,211  
 Sound reproducing instrument, W. H. McCurdy. 909,645  
 Spark arrester, J. E. Knight. 909,610  
 Spark arrester, F. J. Pierce. 909,660  
 Spark coil, J. O. Heinze, Jr. 909,594  
 Sparking igniter, L. H. Wattles. 909,264  
 Speed recorder, A. Turner. 909,482  
 Spindle, P. Seymour. 909,465  
 Spinning, doubling, and twisting machine, F. Seymour. 909,466  
 Spool unwinder, E. J. Rich. 909,456  
 Spoon clamp, engraver's, F. W. Crocker. 909,759  
 Spring. See Automobile spring.  
 Sprinkler alarm and indicator, automatic, F. W. Milliken. 909,311  
 Square, L. V. Shepherd. 909,694  
 Stack, rotary, R. T. Dye. 909,166  
 Stamp gage device, time, H. C. Vizens. 909,731  
 Stand, J. A. Clark. 909,547  
 Stays, piecing, B. V. Kershner. 909,908  
 Steam cooker for oil bearing meal, etc., M. W. Faherty. 909,773  
 Steam cooker for oil bearing meal, etc., A. W. French. 909,778  
 Stipple member, F. C. Newell. 909,444  
 Stirrup, T. E. Alter. 909,736  
 Stone, facing artificial, J. C. Henderson. 909,782  
 Stone tooling machine, J. B. Heighington. 909,296  
 Stove and fireplace backboard, gas, H. Rosamy. 909,678  
 Stove and hot-water heater, gas, J. L. Levering. 909,624  
 Stove oil burner attachment, J. M. Barnes. 909,132  
 Stud pin and seat therefor, W. H. Forthgill. 909,575  
 Stuffing-box, J. W. Walters. 909,263  
 Switch, R. W. Borchert. 909,742  
 Switch frog, J. W. Walls. 909,351  
 Table, W. Hanley. 909,787  
 Tally box, E. K. Hood. 909,185  
 Tank automatic refilling apparatus, pressure, T. P. & T. B. Ford. 909,574  
 Tank operating device, flush, B. O. Tilden, reissue. 12,910  
 Tanning extracts, manufacture of, D. Stewart. 909,343  
 Tap, adjustable, volpsing, Brown & Sprink. 909,749  
 Tapping machine, G. A. Mercier. 909,437  
 Tea and coffee percolator, Gordon & Mumma. 909,178  
 Telautograph, C. F. Jenkins. 909,421  
 Telegraph relay and sounder, combined, A. J. Meyer. 909,198  
 Telegraph system, quadruplex, C. J. App. 909,511  
 Telephone apparatus, E. A. Tytten. 909,414  
 Telephone directory index attachment, E. F. Morton. 909,641  
 Telephone transmitter, J. B. Edwards. 909,566  
 Telephone transmitter, S. A. & R. L. Stienbarger. 909,702  
 Telephone transmitter attachment, J. S. Wincrantz. 909,356  
 Terminal connector, W. C. Tregoning. 909,481  
 Thread-finishing machine, silk, E. Pohl. 909,332  
 Threads, producing cellulose, E. Thiele. 909,257  
 Tie plate and guard rail brace, combined, Reinoehl & Weaver. 909,670  
 Tie, A. S. Janin. 909,603  
 Tire, E. T. Greenfield. 909,180  
 Tire metallic thread, pneumatic, M. C. St. John. 909,475

Tires, making, E. T. Greenfield. 909,181  
 Tobacco press, A. I. Fjelsted. 909,174  
 Tobacco stick holder, J. H. Backston. 909,255  
 Toilet set pocket, A. S. Yorks. 909,273  
 Tongue shaping machine, C. W. Borg. 909,530  
 Tool coupling, pneumatic, A. Hebert. 909,790  
 Tool for securing the covers in paint tins, etc., Taylor & Muller. 909,254  
 Tool, glass severing, L. J. Pierce. 909,451  
 Tool lubricator, pneumatic, J. C. Beckfield. 909,740  
 Tool, molder's, J. H. Casson. 909,150  
 Tooth crowns, etc., molding, Shimura & Minagawa. 909,696  
 Torpedo, E. O'Toole. 909,321  
 Towel rack, H. B. Rose. 909,679  
 Toy or ornament, A. A. Shaw. 909,467  
 Toy, pyrotechnic, A. & C. Weinrich. 909,295  
 Track fastening and tie, D. A. Brubaker. 909,144  
 Tracker bar, G. P. Brand. 909,532  
 Train order holding and delivering device, Greene & Burdett. 909,585  
 Trap, P. S. Hicks. 909,797  
 Trolley, E. H. Green. 909,584  
 Trolley pole fastening, O. L. Spry. 909,247  
 Trolley wire hanger, H. Schutte. 909,691  
 Trolley wire support or hanger, C. G. Ette. 909,569  
 Truck dynamo drive, car, E. T. Ford. 909,573  
 Trunk border piece, traveling, B. Marsteller. 909,630  
 Trunks, automatic tray lifter for, C. A. Wells. 909,837  
 Truss, Mayer & Strahmann. 909,435  
 Tube mill, H. W. Hardinge. 909,292  
 Tubular structures, reinforcing, Hilborn & Roehl. 909,299  
 Turbine, Kelly & Tschinkel. 909,191  
 Turbine, Culver & Heckard. 909,369  
 Turbine, fluid pressure, O. Richter. 909,226  
 Turbine, impulse, M. J. Scanlon. 909,684  
 Typewriter cabinet, W. Hetterschied. 909,796  
 Typewriter carriage return mechanism, E. A. Burlingame. 909,539  
 Typewriting machine, M. W. Pool. 909,334  
 Typewriting machine, H. H. Steele. 909,473  
 Typewriting machine, C. S. Labofish. 909,616  
 Typewriting machine indicator attachment, A. H. Partridge. 909,656  
 Vallise, S. P. S. Patch. 909,325  
 Valve, E. V. Anderson. 909,510  
 Valve, A. W. Cash. 909,545  
 Valve-controlling mechanism, signal, Turner & Lewis. 909,717  
 Valve, flushing, T. R. Jenkins, Jr. 909,605  
 Valve for stand-pipes, balance, Short & Cooley. 909,697  
 Valve for tie pumps, pressure controlling, J. Desmond. 909,373  
 Valve mechanism, Illmer & Kunze. 909,187  
 Valve operating device, flushing, C. H. Bacon. 909,517  
 Vase forming apparatus, J. G. Moritz. 909,640  
 Vault core-releasing device, burial, J. L. Gaskill. 909,394  
 Vehicle, A. Hage. 909,402  
 Vehicle body holder, W. C. Burris. 909,845  
 Vehicle cushion, P. F. Guthrie. 909,400  
 Vehicle thill, adjustable, G. H. Mathews. 909,310  
 Vehicle shaft support, J. R. Scruggs. 909,693  
 Vehicle storm front, G. W. Scott. 909,237  
 Vehicle wheel tire, A. M. Janofsky. 909,419  
 Vehicle wrench, C. J. Atkins. 909,514  
 Vending machine, J. Schmidt. 909,687  
 Ventilator, J. W. Ellis. 909,381  
 Ventilator, R. F. Hunter. 909,601  
 Ventilator, F. Emmenegger. 909,772  
 Vessel, double walled, M. Neuner. 909,203  
 Vessel, double walled, C. S. Reed. 909,221  
 Viduals, apparatus for transporting cold and hot, Straub & Steinhilber. 909,252  
 Violin tuning peg, Calvert & Frisbie. 909,753  
 Wagon dump, J. E. Camp. 909,281  
 Wall supporting device for trenches, W. Z. Laughterback. 909,808  
 Washer. See Bottle washer.  
 Washing machine, R. E. L. Johnston. 909,803  
 Washtub and sink, combined, T. N. Furlong. 909,392  
 Water hydrant, Payne & Ross. 909,327  
 Water-of-condensation-cleaning apparatus, B. E. Van Auken. 909,484  
 Water waste preventer, F. J. Morgan. 909,638  
 Well packer, W. H. & L. P. Kesselman. 909,609  
 Wheel chair, C. L. Hockney. 909,411  
 Wheel tire rim, J. A. Connor. 909,238  
 Whip holder, H. G. Weatherill. 909,718  
 Whip socket, W. Luther. 909,629  
 Wind wheel, J. Dawes. 909,764  
 Windmill attachment, I. J. Folly. 909,175  
 Window cleaner and wiper, combined, C. E. Hening. 909,793  
 Window fastener, show, J. Windle. 909,267  
 Wire covering machine, W. H. Taylor. 909,709  
 Wire crimping machine, J. S. Barnes. 909,738  
 Wire tension device, planter check, W. J. Lundgren. 909,196  
 Work rest, W. J. Brennan. 909,143  
 Wrench, W. J. Stenger. 909,474  
 Wrench, W. O. Kyle. 909,613  
 Wrench, J. W. Hurley. 909,799

**DESIGNS.**

Ash cup, match box, and glass holder, L. W. Rice. 39,753  
 Basin cock, H. Mueller. 39,756  
 Card rack, I. Hahn. 39,755  
 Corset protecting shield, A. R. Moses. 39,760  
 Emblem, F. Sutterlin. 39,749  
 Electric electric wires, branch box for, M. Havens, Jr. 39,761  
 Lamp, street, S. M. Colburn. 39,759  
 Lead pencil, E. L. Schmitz. 39,758  
 Ring, finger, Locher & Kelly. 39,750  
 Salt or pepper box, J. L. Stowicek. 39,752  
 Spool holder for sewing machine stands, W. C. Foley. 39,754  
 Spoons, forks, or similar articles, handle of, J. E. Birmingham. 39,751  
 Statue support, C. P. Monash. 39,769  
 Top, double, C. L. Cruver. 39,757

**TRADE MARKS.**

Bags, hand, Adolph Raudnitz Co. 72,264  
 Bags, satchels, and pocket-books, hand, W. Rueter. 72,257  
 Barbers' and other chairs, head rest attachment for, Kandle Head Rest Co. 72,250  
 Beer, Home Brewing Co. 72,223  
 Bib and faucet handles, self-closing, H. Mueller Manufacturing Co. 72,222  
 Biscuits, tea, Consumers Biscuit and Manufacturing Co. 72,210  
 Bismuth bitannate, a pharmaceutical preparation, Heyden Chemical Works. 72,248  
 Boots and shoes, cloth, rubber, and leather, C. E. Webber. 72,298  
 Boots and shoes, leather, Joseph Strasburger Co. 72,282  
 Brandies, cognac, Martell & Co. 72,228  
 Bread, Lamont Bros. 72,225  
 Bread, potato, H. J. Mees. 72,229  
 Canes, parasols, and umbrellas, Follmer, Clogg Co. 72,275  
 Canned vegetables and fruits, A. Reiter & Co. 72,274  
 Chemical and pharmaceutical preparations, certain, Heyden Chemical Works. 72,247  
 Cigars, H. Fendrich. 72,270  
 Clothing, certain, Hibben, Hollweg & Co. 72,274  
 Clothing, certain, L. Sivins. 72,293  
 Clothing, certain, Tootle Campbell Dry Goods Co. 72,296  
 Clothing, certain, Merrimac Manufacturing Co. 72,300  
 Cloths and worsteds for garments, Schwarzwaeider Co. 72,292  
 Coffee, Richard Bros. 72,231  
 Coffee and tea, Brownell & Field Co. 72,215  
 Coffee, blended, Bennett Sloan & Co. 72,213  
 Corsets and corset waists, J. Garfinkle. 72,276  
 Corsets, corset waists, and corset covers, A. M. Jones. 72,283  
 Cotton duck, John Boyle & Co. 72,281  
 Cough syrup, J. Dumas. 72,242  
 Cutlery, certain, D. Peres. 72,302  
 Ducks and drills, waterproofed, Wellington, Sears & Co. 72,299  
 Effervescent salts, Mu-col Co. 72,262  
 Egg preservative, W. R. Wolfpack. 72,237

Classified Advertisements

Advertising in this column is 75 cents a line. No less than four nor more than ten lines accepted. Count seven words to the line. All orders must be accompanied by a remittance. Further information sent on request.

MUNN & CO.

BUSINESS OPPORTUNITIES.

YOU CAN SECURE a \$25,000 estate by making 100 payments of \$20 each. This is only possible by taking advantage of a condition which is rapidly becoming serious and which opens the way to almost unlimited possibilities for those who take advantage of the opportunity.

Inquiry No. 8735.—For parties making a still for the purpose of extracting alcohol from saw-dust.

FOR SALE.—Plantation at Punta-Gorda, Florida, on Charlotte Harbor, four acres land, cleared, fenced, 1/2 mile from depot, post and telegraph offices. Contains 100 trees—orange, grapefruit, tangerines, etc., many bearing. A bargain. J. E. L., Box 773, New York.

Inquiry No. 8779.—For parties manufacturing gas, gasoline, steam engines and boilers; also packing and mineral wool, steam supplies, iron and lead pipe, power transmission machinery and steam fitters' tools.

PARTNER WANTED with capital to start manufacturing new articles just patented. Manufacturer or cabinet maker preferred. Jos. Rotzay, 1433 Ave. A, New York City.

Inquiry No. 8847.—Wanted laundry tubs.

SALESMAN will act as resident representative in Greater New York. Party having first-class article. Hustler. Best references. Correspondence solicited. Eugene Crowell, 13-21 Park Row, New York City.

Inquiry No. 8863.—Wanted to buy machine to separate pecan nuts into sizes and dust the dirt off.

TO INVENTORS—We will finance and push a good patented article. Write giving full particulars. Address Inventors, Box 773, New York.

PATENTS FOR SALE.

FOR SALE for cash or lease on royalty, combination lister cultivator and disk harrow. Adjustable in every way and reversible. Simple construction, durable, easy to manufacture. J. E. Courtright, Independence, Kan.

Inquiry No. 8868.—Wanted to buy nickeloid for buttons.

FOR SALE.—Patent No. 905,986. Collapsible paste tube with brush attachment, brush and nozzle. May be either manufactured integral with or separate from the tube. For full particulars address C. M. Cole, 1814 Grove Street, Berkeley, Cal.

Inquiry No. 8869.—Wanted to buy straw making machinery.

FOR SALE.—Patent No. 732,225, being for an automatic force feed lubricator. This must be sold to close an estate. For full information address W. C. Saul, Administrator, Carroll, Iowa.

Inquiry No. 8871.—Wanted to buy chimneyless kerosene burners.

MANUFACTURING FIRMS desiring to buy, lease or manufacture a patented article of unquestionable merit should write for working model. Simple, inexpensive. Ready market assured. F. E. Lawrence, Santa Rosa, Cal.

Inquiry No. 8874.—For manufacturers or importers of metal known as "Kaiserzium."

PATENT ON ROYALTY.—Will place on royalty the best transmission and drive construction for automobiles, etc., ever invented. Independent individual speeds. Address B. 911 Stephen Girard Bldg., Phila., Pa.

Inquiry No. 8877.—For manufacturers of convex glass for pictures.

FOR SALE ON ROYALTY BASIS.—Two patents were granted me on hot water and steam heaters October, 1908, which I wish to sell. Address J. V., 238 East Fair Street, New Philadelphia, Ohio.

Inquiry No. 8878.—For factory making paper out of peat.

FOR SALE.—Patent No. 886,162, April 23, 1908. An improvement in hog ring. For particulars address P. A. Swanson, Lynn Centre, Ills.

Inquiry No. 8879.—For the manufacturers of steam air pumps such as are used on the Conrad steam cars.

FOR SALE OR ROYALTY.—Patents No. 808,468, No. 847,703, No. 897,736. Agitators, etc., compressors, etc., engines, etc., steam, double 2-cycle gas and gas producer. Adam Good, 912 Poyntz Ave., Manhattan, Kans.

Inquiry No. 8880.—For manufacturers of portable shower baths.

A MONEY-MAKING PATENT FOR SALE.—Portable coin bin for kitchen and parlor. For full information address A. H. Koch, 228 W. 141st St., New York.

Inquiry No. 8885.—For manufacturers of the "Mysterious Ball" like that of Mr. Lepere's—a man in a ball.

FOR SALE.—Just patented, a perfect Nut Lock. A great money maker. Write me for free sample and full particulars. Address, Frank Matoushek, Gregory, South Dakota.

Inquiry No. 8889.—Wanted to buy a machine which breaks and divides apricot stones.

FOR SALE.—Patent No. 848,469, adjustable table, and No. 900,335, an absolutely safe sealing device for letters and packages. The locking members are enclosed in the paper of the envelope or wrapper itself and not exposed to any instrument, and can be cheaply and easily manufactured. For information address Ernest Kohler, City Market, Alameda, Cal.

Inquiry No. 8890.—For manufacturers of a milk-mixing machine.

MOTION PICTURES.

THE MOVING PICTURE WORLD, weekly, 10 cents per copy; yearly subscription, \$2. The only paper devoted to the moving picture, illustrated songs and lantern lecture field. Moving Picture World, Box 450, N.Y.

Inquiry No. 8891.—For manufacturers of a patent vise with an attachment for boring small holes.

LISTS OF MANUFACTURERS.

COMPLETE LISTS of manufacturers in all lines supplied at short notice at moderate rates. Small and special lists compiled to order at various prices. Estimates should be obtained in advance. Address Munn & Co., List Department, Box 773, New York.

Inquiry No. 8893.—Wanted to buy a second-hand adding machine.

A LIST OF 1,500 mining and consulting engineers on cards. A very valuable list for circularizing, etc. Price \$15.00. Address Munn & Co., List Department, Box 773, New York.

Inquiry No. 8894.—For manufacturers of an automatic camera for making photographs on pin trays, etc.

MISCELLANEOUS.

FOR MEN.—All Safety Razor Blades 2 1/2 cents each. Double edge blades a specialty. We sterilize, resharpen and return your own blades better than new. Send address for convenient mailing package. Keenedge Co., 842 Keenedge Building, Chicago.

Inquiry No. 8897.—For the manufacturers of the "Lid on" can opener.

Inquiry No. 8899.—For manufacturers of steel balls used for cutting sapphires or jewelry and also corn crisp used in cleaning and polishing sapphires.

Inquiry No. 8902.—For the manufacturers of an axle grease known as "Ironside."

Inquiry No. 8903.—For firms dealing in motor cars to suit Indian climate.

Inquiry No. 8904.—Wanted to buy new or second hand machinery for making "bow type" mouse and rat trap springs and wire parts, single machine or full outfit.

Inquiry No. 8907.—For address of New England Coil Winding Co.

Inquiry No. 8908.—For a dealer in tapes and cords for Venetian blinds.

Inquiry No. 8909.—For a machine to paint shade or blind rollers.

Inquiry No. 8911.—Wanted to buy steamfitter's tools and screw-cutting lathes.

Inquiry No. 8915.—For parties who sell plans and specifications for building ice boats.

Inquiry No. 8916.—Wanted to buy a shoe-shiner that can be attached to a wall with a last to fit any man's shoe.

Inquiry No. 8917.—For a manufacturer who will make palmetto brushes to order.

Inquiry No. 8918.—For manufacturers of "Wyd't's Electro-Catalytic Sparking Plug."

Inquiry No. 8919.—For firms dealing in household novelties.

Inquiry No. 8920.—For a still for extracting alcohol from saw dust.

Inquiry No. 8921.—For the manufacturers of gilt paper.

Inquiry No. 8922.—Wanted the address of Worthington Boiler Co.

Inquiry No. 8923.—For a process, chemical or mechanical, by which black pearls may be bleached into white ones, their natural gloss not being affected.

Inquiry No. 8924.—For parties who make an apparatus for bluing small wire nails.

Inquiry No. 8925.—For an explosive turbine or rotary gasoline engine 6 or 8 H. P., must have a vertical shaft.

Inquiry No. 8926.—Wanted to buy a tree digger of steel plates which are forced down beside the tree and locked in position.

Inquiry No. 8927.—Wanted to buy an apparatus for sterilizing water at the tap by an ozonizer.

Inquiry No. 8928.—For the manufacturers of a steam rotary excavator as described in the Scientific American of December 12, 1908, page 347.

Embroidered emblems, Eisner, Spier & Rauner

Enameled sheet metal ware, Norvell-Shap

Fertilizers, Federal Chemical Co.

Fertilizers, sugar cane, New Orleans Acid and Fertilizer Co.

Flannels, Elder & Johnson Co.

Flour, wheat, A. B. McCrillis & Son.

Flour, wheat, Elk Eye Milling Co.

Flour, wheat, E. S. Lee.

Games, certain, New Idea Game Co.

Gin, straight, R. Luhrs.

Gloves and mittens, leather, Gordon & Ferguson.

Hardware, certain, Stanley Works.

Harness parts, certain, Enterprise Manufacturing Co.

Hosiery, O. E. H. Huschke.

Ink, writing, L. E. Waterman Co.

Insulated wires and cables, rubber, Hazard Manufacturing Co.

Jewelry for personal wear, Leys, Christie & Co.

Lampblack, Wilkes Martin Wilkes Co.

Latches, bolts, and fasteners, Stanley Works.

Lubricant, graphite, Monarch Manufacturing Co.

Machinery, certain, United Shoe Machinery Co.

Malt beverage, non-intoxicating, Hoster-Columbus Associated Breweries Co.

Matches, J. A. Hunt.

Medicinal castor oil, Guy G. Major Co.

Metal culverts and pipes, corrugated, Corrugated Metal Manufacturing Co.

Milk, condensed, Borden's Condensed Milk Co.

Newspapers, comic sections or pages of, New York Herald Co.

Oil cloth and linoleum varnish-like preservative, G. H. Baker.

Ointment, eczema, J. F. Petersen.

Oranges and grape fruit, E. P. Porcher.

Paint and varnish brush, Rennous Kleinle & Co. of Baltimore City.

Pharmaceutical preparations, certain, G. F. Smith.

Paper, monthly farm, Currier Publishing Co.

Perfumes and toilet waters, A. J. Hilbert & Co.

Pulp plates and dishes, molded, Keyes Fiber Co.

Remedy for anemia, aromatic iron tonic as a Knoll & Co.

Remedy for piles, Chicago Pharmacal Co.

Ribbons, W. Openlym & Sons.

Roofing, composition, American Roofing Co.

Sherry, Spanish, Elder-Harrison Co.

Shoes and slippers, ladies' leather, S. J. Pentler.

Shoes, certain, Pontiac Shoe Manufacturing Co.

Shoes, certain, Slater & Morrill.

Shoes, certain, Stilson Kellogg Shoe Co.

Soaps, J. W. Wilbur.

Stamp books and sheets, postage, E. L. Warner.

Stokers for furnaces, mechanical, Oscar Barnett Foundry Co.

Telephones, Standard Manufacturing Co.

Tools, certain, United Shoe Machinery Co.

Typewriting machine, Wyckoff, Seamans & Benedict.

Waists, ladies' Anekstein & Kram.

Washing compound, detergent, H. F. Blakeley.

Water, natural lithia, J. P. Porter.

Whiskies, blend of straight rye, F. Handrich & Sons.

Wigs for human beings and dolls, W. Ginsberg.

LABELS.

"Amora," for cigars, C. B. Henschel Mfg. Co.

"Drapery Serpentine Crepe," for crape cloth intended for drapery and upholstery uses, Pacific Mills.

"Dudley Mint Chewing Gum," for mint chewing gum, Cincinnati Commercial Co.

"La Pelata," for cigars, C. B. Henschel Mfg. Co.

"Mi Rey," for cigars, R. Rey.

"Red Rose," for beer, Independent Breweries Co.

"The Great National Catarrh Remedy," for medicine, G. W. Mellinger.

A printed copy of the specification and drawing of any patent in the foregoing list, or any patent in print issued since 1863, will be furnished from this office for 10 cents, provided the name and number of the patent desired and the date be given. Address Munn & Co., 361 Broadway, New York.

Canadian patents may now be obtained by the inventors for any of the inventions named in the foregoing list. For terms and further particulars address Munn & Co., 361 Broadway, New York.

Do You Know Whether You Are Getting Good Typewriter Paper?



LOOK FOR THIS WATERMARK

OLD HAMPSHIRE BOND

How do you buy it?

Do you simply ask for so-much typewriter paper?

Even though you call for the same number, you probably get one grade one time, and another grade the next time. No uniformity.

You might as well send your office boy to buy clothes of size so and so.

There is as much difference between typewriter papers as there is between clothes. You want something that represents your taste and your character.

Old Hampshire Bond Typewriter Paper is now sold in boxes, at most stationers.

You can identify it by the seal on the box, or by the watermark on every sheet of the paper.

It's a paper which will worthily present and preserve your written word—whether a letter or a legal or business document, an essay or whatever you may set down.

Strong enough to stand much handling. And its color-tones are permanent.

Old Hampshire Bond Typewriter Paper is "made a little better than seems necessary." A paper of highest quality, for those who have high standards, and who wish to evidence them in their stationery.

In case you have difficulty in securing Old Hampshire Bond from your stationer, send us \$2 and we will forward you, prepaid, a box of medium weight.

A specimen book will be mailed upon request

Hampshire Paper Co. South Hadley Falls, Mass.

The only paper makers in the world making bond paper exclusively.

LET US BE YOUR FACTORY STAMPINGS, MODELS, EXPERT WORK THE GLOBE MACHINE AND STAMPING CO. 970 Hamilton St., Cleveland, O.

DO YOU USE GRINDSTONES? If so we can supply you. All sizes mounted and unmounted, always kept in stock. Remember, we make a specialty of selecting stones for all special purposes. Send for catalogue "1" The CLEVELAND STONE CO. 2d Floor, Wilshire, Cleveland, O.

ICE MACHINES Corliss Engines, Brewers' and Butlers' Machinery. THE VILBER MFG. CO., 899 Clinton St., Milwaukee, Wis.

MODELS & EXPERIMENTAL WORK. Inventions developed. Special Machinery. E. V. BAILLARD, 24 Frankfort Street, New York.

RUBBER Expert Manufacturers Fine Jobbing Work PARKER, STEARNS & CO., 228-229 South Street, New York

HOEFT & COMPANY Die Makers, Model Makers, Machinery Builders, Punch Presses, Light and Heavy Stampings. 130 Michigan St., Chicago, Ill., U.S.A.

MODELS CHICAGO MODEL WORKS ESTABLISHED 1867 172 E. MADISON ST. CHICAGO, ILL.

Experimental & Model Work Cir. & advice free. Wm. Gardam & Son, 221 Fulton St., N.Y.

LEARN WATCHMAKING We teach it thoroughly in as many months as it formerly took years. Does away with tedious apprenticeship. Money earned while studying. Positions secured. Easy terms. Send for catalog.

ST. LOUIS WATCHMAKING SCHOOL, St. Louis, Mo.

DRYING MACHINES For Steamed Rice Paddy and many other granular and pulverized materials. S. E. WORRELL, Hannibal, Mo., U. S. A.

THE SCHWERDTLE STAMP CO. STEEL STAMPS, LETTERS & FIGURES BRIDGEPORT CONN.

A popular illustrated account of how the forces of science are being marvelously applied to modern industry

The Chemistry of Commerce

By Robert Kennedy Duncan Author of "The New Knowledge"

The Chemistry of Commerce is a graphic narrative of the wonderful work of applied chemistry in the industrial world today. It affords an engrossing story of the invention and manufacture of commodities that are close to the business or home interests of each one of us. It is packed with information upon such topics as the making of artificial rubies and diamonds, of nonbreakable Welsbach mantles, of the distillation of perfumes in quantities sufficient to float a frigate, of the coloring of glass, of the engineering feats accomplished by high temperatures, the preparation of drugs like camphor and quinine, the extraordinary future of industrial alcohol.

Illustrated. \$2.00 net

HARPER & BROTHERS, PUBLISHERS, NEW YORK CITY

What Do You Want To Buy?

We can tell you where to buy anything you want. Write us for the addresses of manufacturers in ANY line of business. Novelties, Special Tools, Machinery, Equipments. New Patent LABOR-SAVING DEVICES.

MUNN & CO., Publishers of Scientific American 361 Broadway, New York, U. S. A.

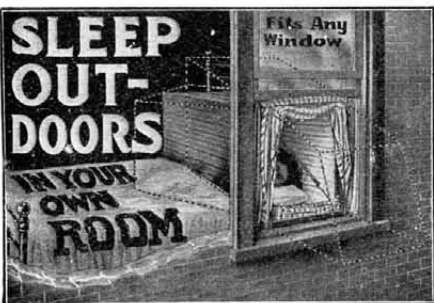

**SLEEP OUT-DOORS IN YOUR OWN ROOM**  
 Fits Any Window  
 The Superior Window Tent is so made that while your body is enjoying the comforts of a warm room, only the face comes in contact with the crisp, out-door air, which enables you to get all the benefits derived from out-door sleeping with none of the dangers and disadvantages of sleeping in tents, on roofs or porches; no drafts; no need of heavy covers, which use up vitality. Amount of air entering can be regulated. The awning shields you from rain, snow, drafts or any other exposures. Sleep in nature's pure, fresh air and arise invigorated, refreshed and robust. For full, free particulars of this inexpensive device, which is recommended by the medical profession, address  
**Cabinet Mfg. Co., 301 Main St., Quincy, Ill.**  
 Manufacturers of Superior Bath Cabinets for Turkish and Vapor Baths.

**LEARN TO BE A WATCHMAKER**  
 Bradley Polytechnic Institute  
 Horological Department  
 Peoria, Illinois  
 Formerly Parsons Horological Inst.  
 Largest and Best Watch School in America  
 We teach Watch Work, Jewelry, Engraving, Clock Work, Optics. Tuition reasonable. Board and rooms near school at moderate rates. Send for Catalog of Information.

**CRUDE ASBESTOS DIRECT FROM MINES**  
 PREPARED ASBESTOS FIBRE for Manufacturers use  
**R. H. MARTIN,**  
 OFFICE, ST. PAUL BUILDING  
 220 B'way, New York.

**A Cheap Water Power**  
 As a reliable and economical water power for public institutions, farmers, owners of factories and country homes, the  
**Niagara Hydraulic Ram**  
 has no equal. Better than a gasoline engine or windmill. Send for booklet and estimate. We furnish Caldwell Tanks and Towers.  
**NIAGARA HYDRAULIC ENGINE CO.,**  
 140 Nassau St., N. Y. Factory, Chester, Pa.

**POPULAR ELECTRICITY IN PLAIN ENGLISH**  
  
 A monthly magazine for everybody; non-technical, profusely illustrated, intensely interesting and instructive. Puts you on electricity in all its applications. \$1.00 per year, including an ELECTRIC ENGINE like above illustration; engine will run a long time on one wet or dry battery—1,000 revolutions per minute. A marvel of skilled workmanship. (Cut 1/2 size.)  
 Send for Electrical Premium List.  
**POPULAR ELECTRICITY PUBLISHING CO.,**  
 1200 Monmouth Block CHICAGO, ILL.

**I TEACH Penmanship BY MAIL**  
 I won the World's First Prize in Penmanship. By my new system I can make an expert penman of you by mail. I also teach Book-keeping and Shorthand. Am placing my students as instructors in commercial colleges. If you wish to become a better penman, write me. I will send you FREE one of my Favorite Pens and a copy of the Ransomeian Journal. Inclose stamp.  
**C. W. RANSOM,**  
 8824 Euclid Ave., Kansas City, Missouri.

**Salesmen Wanted!**  
 Be a high grade Traveling Salesman and earn from \$1,000 to \$10,000 a year and expenses. We will prepare you by mail in eight weeks to be one and assist you to secure a good position. Hundreds of our graduates now holding good positions we secured for them, with reliable firms. Many who had no former experience now earn \$100 to \$500 monthly and expenses. If you want to secure a good position and increase your earnings our Free Book, "A Knight of the Grip" will show you how. Send for it today. Address nearest office.  
**DEPT. 20 NATIONAL SALESMEN'S TRAINING ASSOCIATION, Chicago, New York, Kansas City, Minneapolis, San Francisco.**

**Save Money by Machinery!**  
 You can do this easily with the right machine in all furniture factories.  
**DODDS' TILTING CIRCULAR SAW**  
 upfits to 45 degrees, simplifies the work and insures perfect accuracy in cutting. Removable throat in table. 12-inch rip or cross-cut saw with each machine. Write for free illustrated catalogue and price list.  
**ALEXANDER DODDS, Grand Rapids, Mich., U. S. A.**

**Pipe Cutting and Threading Machine**  
 For Either Hand or Power  
 This machine is the regular hand machine supplied with a power base, pinion, countershaft, etc., and can be worked as an ordinary power machine or taken from its base for use as a hand machine. Pipe 1/2 in. to 1 1/2 in. diameter handled easily in small room. Illustrated catalogue—price list free on application.  
**THE CURTIS & CURTIS CO.,**  
 6 Garden St., Bridgeport, Conn. Branch Office, 60 Centre St., N. Y.

**WE WILL MAKE your models and give you estimates on manufacture of any metal novelty. Automatic machinery, tools, dies and expert work our specialty.**  
**AUTOMATIC HOOK & EYE CO., Hoboken, N. J.**



**Until you have heard Amberol Records you have not heard the Edison Phonograph at its best**

Edison Amberol Records have made the Edison Phonograph a more fascinating entertainer than before—added richness and sweetness to its tone, increased its repertoire and enabled it to give to more people more of the kind of music they enjoy.  
 Consider the increased enjoyment of a Record that plays twice as long as the regular Edison Record and longer than any other Record made.  
 Go to the nearest dealer today and hear the Edison Phonograph play an Amberol Record. He will tell you how you can play it on your present Phonograph and still play the records you have.  
 Ask your dealers or write us for catalogues of Edison Phonographs and Records.  
**National Phonograph Co., 133 Lakeside Avenue, Orange, N. J.**

**"CASTELL"**  
**DRAWING PENCILS. Made in 16 degrees, 6B to 8H THE FINEST IN EXISTENCE**  
 Sold by all stationers and dealers in artists' materials. Sample sent to all parties interested on receipt of 10c, in postage stamp,  
**A. W. FABER, 49 Dickerson Street, Newark, N. J.**

**American Homes and Gardens**

gives its readers the experience of experts in solving the most difficult HOME PROBLEMS. It is a thoroughly practical magazine, having the word "Home" for its keynote.  
**HOW TO BUILD THE HOME**  
 Floor plans and details of construction of houses of moderate cost as well as more pretentious mansions are a feature of each issue.  
**HOW TO DECORATE THE HOME**  
 The most experienced decorators in the country describe how the best and most artistic results are attained from the point of expenditure, and the more important one of satisfaction.  
**HOW TO PLAN AND LAY OUT THE GARDEN**  
 The frame of the House-picture is the garden, and success in its treatment means that each tree and shrub is correctly placed as well as properly grown, hence this department will be found most helpful.  
**OUTDOOR LIFE AND AMUSEMENTS, ARTICLES ON HOUSE INDUSTRIES,**  
 every phase of country life is authoritatively discussed from month to month in its pages. "American Homes and Gardens" is conceded to be the handsomest magazine published in America. Its beautiful cover printed in colors changes each month, and is always a work of art. **Subscription price, \$3 per year.** If we receive your order for a year's subscription now we will send you the November and December, 1908, numbers free; in other words, fourteen months for price of a year's subscription.

**The Season's Best Club Combinations**

Scientific American or American Homes and Gardens . . . . .	\$3.00	} \$4.45	Scientific American or American Homes and Gardens . . . . .	\$3.00	} \$5.35
Review of Reviews . . . . .	3.00		McClure's Magazine . . . . .	1.50	
	\$6.00		Review of Reviews . . . . .	3.00	
Scientific American or American Homes and Gardens . . . . .	\$3.00	} \$6.80	Scientific American or American Homes and Gardens . . . . .	\$3.00	} \$5.10
Review of Reviews . . . . .	3.00		World's Work . . . . .	3.00	
World's Work . . . . .	3.00		Delineator . . . . .	1.00	
Everybody's Magazine . . . . .	1.50		\$7.00		
	\$10.50				
Scientific American or American Homes and Gardens . . . . .	\$3.00	} \$5.35	Scientific American or American Homes and Gardens . . . . .	\$3.00	} \$4.60
Everybody's Magazine . . . . .	1.50		McClure's Magazine . . . . .	1.50	
World's Work . . . . .	3.00		Woman's Home Companion . . . . .	1.25	
	\$7.50		\$5.75		

After February 1, 1909, 25c. must be added to combinations including Woman's Home Companion.

**MUNN & CO., 361 Broadway, New York City**

**Engineering News**

(ILLUSTRATED)  
 The Leading Engineering Paper of the World. For Civil, Mechanical, Mining and Electrical Engineers  
 100 to 125 pages, 9" x 13", weekly. Send ten cents for sample copy.  
 If you cannot locate desired engineering equipment write our "Readers Want" department.  
**THE ENGINEERING NEWS PUBLISHING CO. 214 Broadway, New York**

**COLD GALVANIZING. AMERICAN PROCESS. NO ROYALTIES. SAMPLES AND INFORMATION ON APPLICATION.**  
**NICKEL**  
 Electro-Plating Apparatus and Material  
**Hanson & VanWinkle Co.,**  
 Newark, N. J.  
 28 & 30 S. Canal St. Chicago.

**THIS GRINDER**  
 Has no pumps, no valves. No piping required to supply it with water. Always ready for use. Simplest in construction, most efficient in operation. Price still interest you.  
**W. F. & J. O. BARNES CO.,**  
 Established 1875  
 1999 Ruby St., Rockford, Ill.

**BENJAMIN AIR RIFLE FOR MEN AND OLDER BOYS**  
 NOT A TOY but a pneumatic gun operated by compressed air. Shoots with ten times the force of an ordinary spring gun, accurately, 10 or 15 cents pays for 1,000 shots. Barrel full nickeled, walnut stock. The ideal gun for shooting small game, a perfect rifle for target practice. Shoots through one-half inch pine board and more. Fully guaranteed. Sold by dealers and jobbers everywhere. If your dealer does not sell it, write us. Sent prepaid in U. S. and Parcel Post countries upon receipt of price, \$2.50. Address  
**BENJAMIN AIR RIFLE & MFG. CO., 601 N. Broadway, St. Louis, Mo.**

**WILL YOU SELL** a patent, patentable idea, or any money making proposition upon which it is possible to get a patent, trademark or copyright, or that can be protected by secret process? Will you sell your automobile, bonds or securities, business or other property, including any form of real estate? If so, send QUICK price, terms, description with reference.  
**MYRICK SYNDICATE, Springfield, Massachusetts**  
 Ours is the largest body of cash buyers in America—a market at a fair price for everything of merit.

**"Aeronautics" American Journal of Aerial Locomotion**  
 Read the Enormous Progress in Flying Machines and Airships.  
 Nothing happens aeronautically anywhere in the world unrecorded in this magazine.  
 The Only Aero Journal in America. Third year.  
 Send for sample copy.  
 1775 Broadway, New York

**TYPEWRITERS ALL MAKES**  
**Visible Writers** or otherwise **Olivers, Remingtons, Smiths, etc.**  
 Shipped ANYWHERE for Free Trial, or RENTED, allowing RENT TO APPLY.  
**Prices \$15.00 Up**  
 First class Machines fresh from the Manufacturers  
 Write for Illustrated Catalog 10. Your opportunity.  
**TYPEWRITER EMPORIUM, (Est. 1892) 92 & 94 Lake St. Chicago**

**Concrete, Reinforced Concrete AND Concrete Building Blocks**  
 Scientific American Supplement 1543 contains an article on Concrete, by Brysson Cunningham. The article clearly describes the proper composition and mixture of concrete and gives results of elaborate tests.  
 Scientific American Supplement 1538 gives the proportion of gravel and sand to be used in concrete.  
 Scientific American Supplements 1567, 1568, 1569, 1570, and 1571 contain an elaborate discussion by Lieut. Henry J. Jones of the various systems of reinforcing concrete, concrete construction, and their applications. These articles constitute a splendid text book on the subject of reinforced concrete. Nothing better has been published.  
 Scientific American Supplement 997 contains an article by Spencer Newberry in which practical notes on the proper preparation of concrete are given.  
 Scientific American Supplements 1568 and 1569 present a helpful account of the making of concrete blocks by Spencer Newberry.  
 Scientific American Supplement 1534 gives a critical review of the engineering value of reinforced concrete.  
 Scientific American Supplements 1547 and 1548 give a resume in which the various systems of reinforced concrete construction are discussed and illustrated.  
 Scientific American Supplement 1564 contains an article by Lewis A. Hicks, in which the merits and defects of reinforced concrete are analyzed.  
 Scientific American Supplement 1551 contains the principles of reinforced concrete with some practical illustrations by Walter Loring Webb.  
 Scientific American Supplement 1573 contains an article by Louis H. Gibson on the principles of success in concrete block manufacture, illustrated.  
 Scientific American Supplement 1574 discusses steel for reinforced concrete.  
 Scientific American Supplements 1575, 1576, and 1577 contain a paper by Philip L. Wormley, Jr., on cement mortar and concrete, their preparation and use for farm purposes. The paper exhaustively discusses the making of mortar and concrete, depositing of concrete, facing concrete, wood forms, concrete sidewalks, details of construction of reinforced concrete posts.  
 Each number of the Supplement costs 10 cents.  
 A set of papers containing all the articles above mentioned will be mailed for \$1.80.  
 Order from your newsdealer or from  
**MUNN & CO.**  
**361 Broadway, New York City**

**HEMETOIL LUBRICATES ANYTHING**  
 SEND FOR SAMPLE FREE  
 15-21 S. CLINTON ST.  
**CH. BESLY & CO. NEW YORK, U.S.A.**